

MULTIPHYSICS SIMULATION

Sponsored by
 COMSOL

 IEEE
SPECTRUM

SEPTEMBER 2015

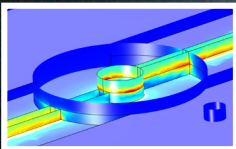

**INTEL IMPROVES
SIGNAL INTEGRITY
AND SPEED**
PAGE 18

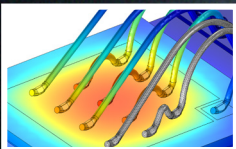

**ABB EXTENDS
LIFETIME OF POWER
TRANSISTORS**
PAGE 20

**SIMULATION
POWERS WIRELESS
CHARGING
AT WITRICITY**

PAGE 8

SIMULATION APPS ARE MOVING TO THE MAINSTREAM

By **JAMES A. VICK**, SENIOR DIRECTOR,
IEEE MEDIA; PUBLISHER, IEEE SPECTRUM

CHANCES ARE THAT THIS ISSUE of *Multiphysics Simulation* will have a profound impact on what you know about simulation. If you think of simulation as the exclusive domain of a select few R&D specialists, then you'll be surprised by the contents of this issue. No longer are the high costs and lack of custom simulation and analysis tools a roadblock for bringing simulation to everyone.

Easy-to-use specialized simulation apps are moving to the mainstream. A great example of a company utilizing simulation apps to improve R&D comes from Cypress Semiconductor of San Jose, CA. Perhaps best known for their smartphone touchscreen solutions, Cypress is using simulation apps to aid in the design of a wide array of consumer and industrial products. The modeling and simulation of capacitive sensors in touchscreens begins with the R&D engineers. However, instead of having to run repetitive simulations for every individual case, they are now building ready-to-use apps and distributing them to other departments. Their worldwide customer support teams can now access these apps and make use of them immediately with no learning curve and at a fraction of the cost of deploying a fully featured model. And the creation and distribution of these apps can all be done within one software environment.

This issue of *Multiphysics Simulation*, sponsored by COMSOL, Inc., offers a great way to learn about simulation application design and innovative simulation projects. If you are designing a power supply unit, first check out the article on wireless power transfer from Witricity—no cords required. Graphene is another topic that has inspired a lot of interest lately and that is now being applied in real-life environments. Within this issue, leading experts from Purdue University discuss how to efficiently and accurately simulate graphene-based photonic devices.

I hope you find this issue of *Multiphysics Simulation* inspiring! © Email: jv.ieeemedial@ieee.org

CONTENTS

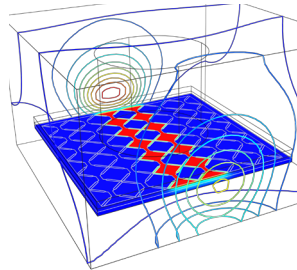

3 GETTING TOUCHY- FEELY WITH TOUCHSCREEN DESIGN

—Cypress Semiconductor,
San Jose, CA, USA

6 COMSOL APPS BRING SIMULATION DEMOCRATIZATION

—COMSOL, Burlington, MA, USA

8 WITRICITY LEVERAGES MAGNETIC RESONANCE FOR FLEXIBLE WIRELESS CHARGING

—Witricity, Watertown, MA, USA

11 MEDTRONIC ADVANCES ABLATION TECHNOLOGY WITH MULTIPHYSICS SIMULATION

—Medtronic, Boulder, CO, USA

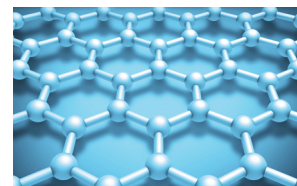

14 GRAPHENE PAVES THE WAY FOR NEXT- GENERATION PLASMONICS

—Purdue University, West
Lafayette, IN, USA

18 DEFYING CONVENTION TO ACHIEVE FASTER SIGNAL AND SIMULATION SPEEDS

—Intel, Guadalajara, Mexico

20 INCREASING LIFESPANS OF HIGH-POWER ELECTRICAL SYSTEMS

—ABB Semiconductors,
Lenzburg, Switzerland

24 BRINGING GLUCOSE MONITORING TO NEW LEVELS THROUGH INTEGRATED SENSOR DESIGN

—Roche Diagnostics,
Indianapolis, IN, USA

27 SIMULATING PRINTHEAD UNIMORPH ACTUATORS AT FUJIFILM DIMATIX

—Fujifilm Dimatrix,
Lebanon, NH, USA

30 HPC-ENABLED SIMULATION AIDS IN THE DESIGN OF CUSTOMIZED HIGH POWER ELECTRICAL DEVICES

—BLOCK Transformatoren-
Elektronik, Verden, Germany



32 SIMULATION APPS STREAMLINE THE DESIGN OF POWER ELECTRONICS

—Arkansas Power Electronics,
Fayetteville, AR, USA

ON THE COVER: An electric vehicle charging wirelessly, parked above a charging pad. Automakers, electronics manufacturers, medical implant designers, and others are working with WiTricity to create a more efficient and consumer-friendly experience in many technology markets. See the full article, starting on page 8, for more details. Illustration is courtesy of WiTricity.

GETTING TOUCHY-FEELY WITH TOUCHSCREEN DESIGN

Cypress Semiconductor uses simulation to optimize touchscreen design for use in diverse products including smartphones, laptops, automotive and industrial applications, home appliances, and more.

By **ALEXANDRA FOLEY**

TO MAKE A PHONE CALL, compose a text message, or even to beat the next level of an Angry Birds™ game, we rely on being able to pick up our smartphone and interact with it without a second thought. No matter the size of our fingers, whether or not we have recently applied hand cream, or if the phone is resting on a flat surface, the touchscreen responds seamlessly, bringing just one more thieving farm animal to justice.

Engineers at Cypress Semiconductor, the leading supplier of smartphone touchscreen technologies and touch-sensing solutions, are hard at work making this possible, ensuring that touchscreen applications perform flawlessly under a variety of conditions. “And it’s not just about smartphones,” says Peter Vavaroutsos, a member of the touchscreen modeling group at Cypress. “Our technologies are used in smartphones, mp3 devices, laptops, automotive environments, industrial applications, home appliances, and more. For each of these uses, a different design is needed.”

Capacitive touchscreens (see Figure 1, top) are by far the most commonly used method of touch sensing in the electronics industry, and consist of varying layers of transparent lenses, substrates, adhesives, and indium-tin-oxide (ITO) electrodes. Together, these elements are known as touchscreen panels (TSPs) or stack-ups. Depending on the type of product in which they will be used, each stack-up and electrode pattern is customized for its intended environment and use. A stack-up (see example shown in Figure 1, bottom) contains an LCD layer, followed by a substrate, a pattern of horizontally and vertically aligned diamond-shaped ITO electrodes, and finally an optically clear adhesive layer that bonds the glass cover onto the screen.

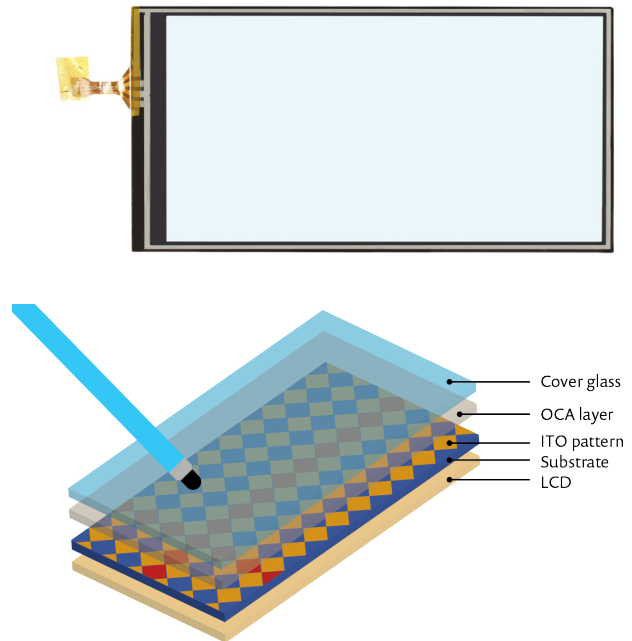

FIGURE 1: Top: Capacitive touchscreen module. Bottom: Typical touchscreen sensor stack-up where a stylus' position is detected because of the change in the electrodes' coupling capacitance.

At Cypress, multiphysics simulation and simulation apps have emerged as key tools for ensuring effective product development, allowing designers to predict and optimize the behavior of numerous designs without needing to build multiple physical prototypes.

» AN ENGINEERING RULE OF THUMB

AS A RULE OF THUMB, touchscreens must track finger or stylus positions with high accuracy. This means that at any point in time, a touchscreen must not only be able to determine that it is being touched by an object of variable size, but also where, for how long,

and whether the “touch object” is moving in a certain direction. To achieve this, a capacitive sensor is composed of a pattern of horizontally and vertically connected ITO electrodes, where a touch object is sensed at the grid intersection. When a finger or stylus touches the screen’s surface, it distorts the electrostatic field and causes a measurable change in the coupling capacitance between the transmitting and receiving electrodes (see Figure 1, bottom).

Depending on where and how the touchscreen will be used, the stack-up components are configured in a variety of ways. “The design of a touch-

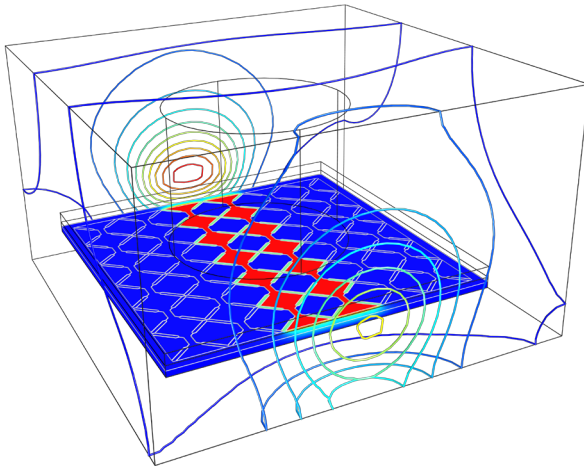

FIGURE 2: Touch sensor with electric field lines modeled using the AC/DC Module, an add-on product to COMSOL Multiphysics.

screen stack-up for the automotive industry is very different than one used in, say, a laptop,” says Vavaroutsos. “My job at Cypress is to design different stack-ups for different consumer products, taking into account such things as how interactions between a horizontally mounted GPS, for example, will differ from a smartphone, which can be held and interacted with in a myriad of different ways.”

Cypress R&D engineers create multiple electrostatic simulations for a particular device geometry and for many different parameters, what the team refers to as a “design box”.

“Our findings from a specific design box are then used by our sales engineers and customer support team so that they can optimize certain design specifications in order to meet a customer’s individual needs,”

explains Vavaroutsos.

Using the COMSOL Multiphysics® simulation software, R&D engineers at Cypress perform analyses to determine the electrical performance of the ITO pattern, including measuring the change in mutual capacitance between electrodes when a stylus or finger is present. In the example shown in Figure 2, floating potential boundary conditions were used in the electrostatic model, a feature that is instrumental in allowing Cypress engineers to simulate the boundaries of touch objects and any electric shielding or electrodes that are not currently being excited. Because these objects are affected by an externally applied electric field, they will be at a constant but unknown electric potential and therefore are represented as surfaces over which a charge can freely redistribute itself.

“Since the screen can be interacted with in so many different ways, in order to optimize a stack-up for use in a certain device or product, we have to run numerous electrostatic simulations in order to test different touch object positions,” says Vavaroutsos. “We try to minimize effects such as when you get water on your screen and it doesn’t work as well, or when you put your phone down on the table and the screen responds poorly. Simulation has been a very valuable tool for ensuring that our product responds effectively over a range of different environments and conditions, since we can single out certain factors and determine how to most effectively optimize performance.”

Because COMSOL® software can be run on unlimited multiple cores and using cluster and cloud computing with no limit to the number of compute nodes, Cypress engineers are able to quickly run many simulations with virtually no limits on the size of the design boxes analyzed. “We can reduce the number of assumptions we have to employ and accurately model capacitive

touchscreens by capturing changes between active electrodes in great detail while working with realistic geometry and materials,” says Vavaroutsos.

Within a single design box, Cypress engineers might test different cover lens thicknesses, alter the permittivity of various layers, or change pattern parameters. Depending on the application area, a single touchscreen may be designed to have more than one electrode layer, or have different layers in a different order. For example, a design box might include a range for cover lens thicknesses from 0.5 millimeters to 1.5 millimeters. The R&D team at Cypress will model a variety of different parameter ranges in order to precisely understand a certain design, but anything outside the modeled range will remain unknown.

» TOUCHSCREEN SIMULATION APPS FOR CUSTOMIZED DESIGNS

IN ORDER TO EXTEND the usability of their models, Cypress engineers are using the Application Builder in COMSOL Multiphysics to create simulation apps based on their models. “In order to communicate more effectively

“Simulation has been a great tool for ensuring that our product responds effectively over a range of different environments and conditions.”

—PETER VAVAROUTSOS, R&D ENGINEER, CYPRESS

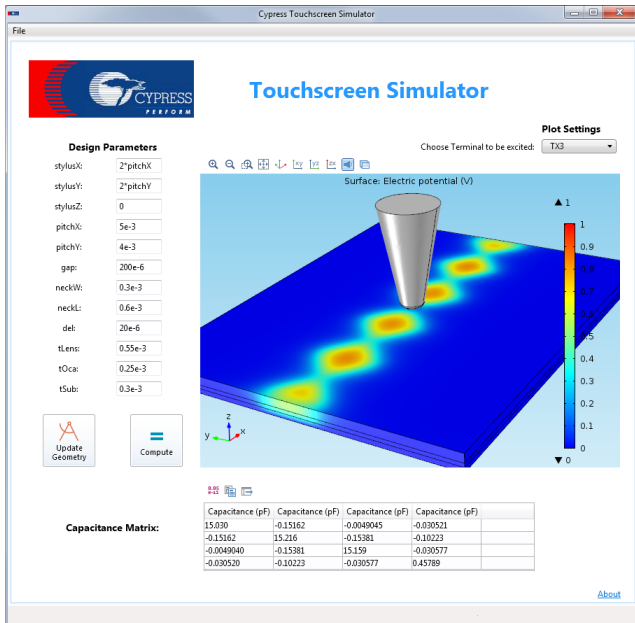

FIGURE 3: Touchscreen app created with the Application Builder and run using a Windows®-native client connected to COMSOL Server™.

with our customer support teams, we've started using the Application Builder to build simplified user interfaces over our models," says Vavaroutsos. "Before we started using simulation apps, any time a customer wanted a design that was slightly outside of the design box, we'd have to be involved again to run simulations for minor parameter changes. A lot of times, a sales engineer might try to run the simulations themselves, even though they had little experience using the COMSOL software. Not only would we have to check the simulations, but they also took up a seat on the software as well."

The example app in Figure 3 shows parameters that could be included in a touchscreen app. The fin-

ger or stylus touching the panel is represented by a conical structure. The app user can change design parameters ranging from the finger location to the thickness of the different layers in the sensor. The app then generates a report detailing the capacitance matrix, an integral piece of information for capacitive sensor design. The app can also show the electric field distribution in the sensor and a drop-down list can be used to select a solution corresponding to the excitation of different sensor traces.

Cypress is also using the COMSOL Server™ license to share their simulation apps with colleagues around the world, which allows anyone to access

simulation apps using either a Windows®-based client or a web browser. "We're finding that letting our support teams have access to multiphysics simulation results is hugely helpful. We can control the parameters that the app user has access to so that we know the apps are delivering accurate results, while also letting our support engineers experiment with thousands of different design options without the need to involve an R&D engineer—or use a seat up on our COMSOL Multiphysics license."

» TEST-DRIVING AUTOMOTIVE TOUCHSCREEN DESIGNS

IN ADDITION TO TOUCHSCREENS for consumer products, Cypress also creates touchscreen designs for use in the automotive industry. For these applications, engineers experiment with different designs in response to certain automobile requirements.

"In the automotive group, our designs are more customer driven and are often created on a case-by-case basis for a specific product or customer," says Nathan Thomas, an R&D engineer working in the automotive group at Cypress. "Our design boxes are irregularly shaped, and we do more simulations that are customer-specific. For example, an automotive company might use touch-

screens for different applications such as in the center console, in rear seat entertainment systems, or in overhead entertainment systems, all of which will need their own models."

Instead of creating a new model for each and every instance, the automotive group is now using apps to let field engineers test new designs that would otherwise have been outside of the design box. The apps can be used to explore special requests from customers who are interested in how varying a parameter will affect end performance. "For cases such as these, we've been using the Application Builder to create simulation apps that our field engineers can apply directly without having to go through us to create the simulation for them. While it's still a new technology, I can foresee simulation apps becoming the primary tool used by our field engineers."

» POWERING UP

WHETHER IT BE SMARTPHONE DESIGNS, automotive applications, or other industrial processes, Cypress R&D engineers can create simulation apps that allow other support engineers to experiment with designs that would otherwise have required the expertise of an R&D engineer. Through the use of simulation, Cypress engineers are delivering more customizable designs faster than ever before. ☺

COMSOL APPS BRING SIMULATION DEMOCRATIZATION

By **ALEXANDRA FOLEY AND VALERIO MARRA**

BEHIND EVERY PRODUCT LAUNCH, every technological innovation and scientific breakthrough, stand a whole team of professionals whose vision, expertise, and commitment have made the product possible. From design engineers to field technicians, to sales engineers and production managers, a wealth of knowledge and expertise surrounds every successful product.

On the R&D side, this knowledge is the work of a team of highly qualified engineers whose job it is to test, analyze, and innovate using advanced computer aided engineering (CAE) tools. With CAE, these R&D engineers build virtual physics models to gain an understanding of how the product will perform when exposed to real-world effects.

Future product updates, customizations for specific uses, or the exploration of different designs, materials, and other optimizations necessitate that simulations be conducted using the physics models developed by the R&D team. "Because of the complexity of these simulations, the engineer who created the model is oftentimes the only one who can safely make modifications and test new designs. In many companies today, this small team is therefore facilitating the work of a much larger group of people, thus creating a bottleneck," says Bjorn Sjodin, VP of Product Management, COMSOL.

How can these powerful computational tools be made available to

a wider user base? Increased access to multiphysics simulation would undoubtedly lead to increased productivity and innovation, but how can this be done in a way that is cost-effective and scalable?

» SIMULATION APPLICATIONS MOVE TO THE MAINSTREAM

THE COMSOL MULTIPHYSICS® software and the Application Builder allow R&D engineers to share their simulation expertise with others in a way that is fast, easy, and customizable (see Figure 1). With the Application Builder, an R&D engineer can readily build an intuitive interface around any COMSOL® software model and customize it for the application's intended use. The resulting simulation app retains the functionality of the original model, but has a simplified user interface (UI) through which the app user can only edit certain inputs, materials, geometry, or other parameters, and then recalculate the new design's expected performance. Such an app can be created from within a single software environment using COMSOL Multiphysics.

Simulation apps can be used for a diverse range of tasks. For example, companies may offer apps demonstrating their product's performance to be used in place of data sheets, or may produce licensable apps as products in their own right. Within a company, a sales or support engineer might use an app to quickly analyze the expected performance, durability, and cost of a specific project by test-

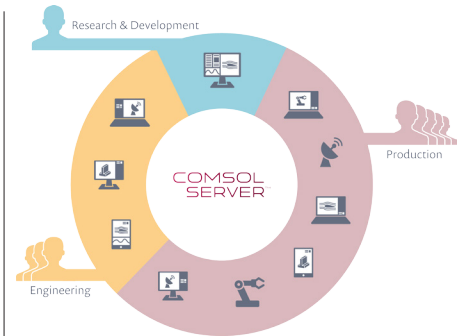

FIGURE 1: Apps are created by the R&D team using the Application Builder, and then used by other departments by connecting to the COMSOL Server™ environment.

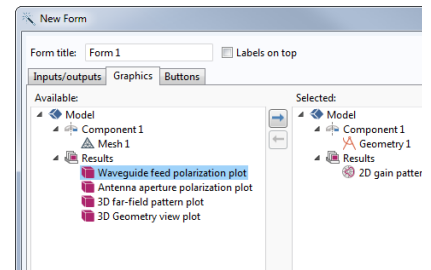

FIGURE 2: New form created with the Form Wizard for the corrugated circular horn antenna demo application, which is available in the COMSOL® software.

ing different materials and designs.

In short, "simulation apps offer a new line of communication between the professional modeling expertise of the model builder, and the rest of the production team," says Bjorn Sjodin.

» BUILDING A SIMULATION APP WITH THE APPLICATION BUILDER

ALL OF THE NECESSARY TOOLS for building a simulation app are accessible within the COMSOL Desktop® environment where the Model Builder and the Application Builder are fully integrated. As an example, consider the model of a corrugated circular horn antenna (available as a demo application in the Application Libraries). After switching from the Model Builder mode to the Application Builder mode, a simple app can be built in

just a few clicks, and can then be further customized and enhanced.

To start, the Form Wizard suggests a list of elements from the model that are suitable for use as inputs and outputs, modeling operations, and graphics (see Figure 2).

The template app created using the Form Wizard can then be updated and customized using two tools: the Form Editor and the Method Editor. With the Form Editor, form objects such as input fields, buttons, graphics windows, and results tables can be added to the app using drag and drop operations (see Figure 3).

After adding these forms, the app can be further customized for additional functionality using the Method Editor, which is essentially a Java® programming environment that allows users to combine the COMSOL® interface with Java® programs and libraries.

In the corrugated horn antenna example (see Figure 4), features created using methods include input-within-bounds restrictions for frequency and wavelength fields, the ability to reset the input parameters back to the default values, and 2D and 3D results visualizations. Additionally, when the app has finished running, it generates a simulation report, which can be automatically emailed to a specified recipient when a computation is complete. The finalized app is shown in Figure 4.

Simulation apps are fully customizable based on the specific needs of the app user and can be created for diverse projects, including for sales representatives looking to modify a design to accommodate the needs of a customer or a design engineer looking to quickly acquire data about the feasibility of a new project. Apps created with the Application Builder and COMSOL Multiphysics make simulation accessible to a wider group of people working in product development, design, or production. The democratization of simulation is happening now! ☺

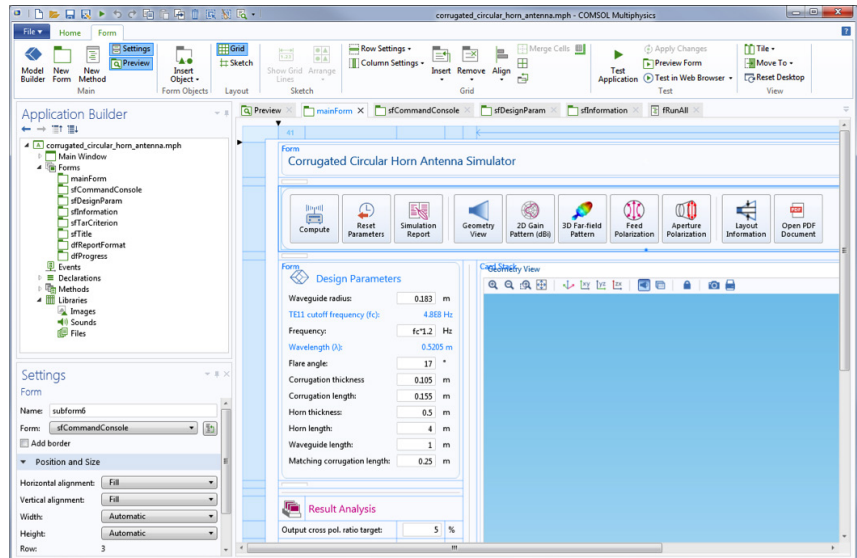

FIGURE 3: The finalized main form of the corrugated horn antenna app consist of forms, card stacks, text labels, input fields, units, images, etc. These objects are available from a drop-down menu in the Form Editor.

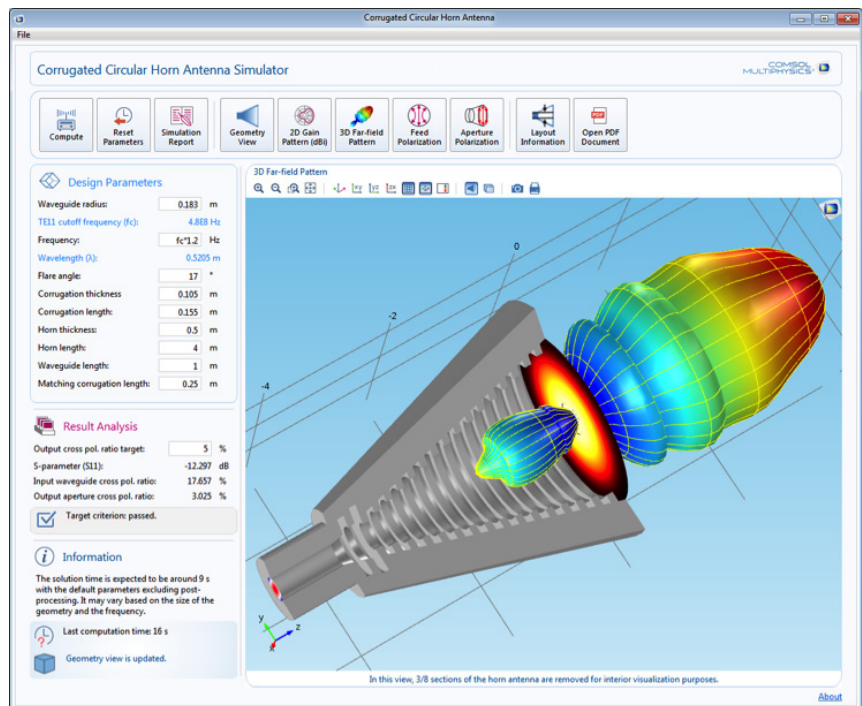

FIGURE 4: An app showing the far-field radiation of a corrugated circular horn antenna. The geometry parameters and operating frequencies can be changed to optimize the antenna's performance.

“Simulation apps offer a new line of communication between the professional modeling expertise of the model builder and the rest of the production team.”

—BJORN SJODIN, VP OF PRODUCT MANAGEMENT, COMSOL

WITRICITY LEVERAGES MAGNETIC RESONANCE FOR FLEXIBLE WIRELESS CHARGING

Engineers at WiTricity have used multiphysics simulation in the innovative development of wireless power transfer technology that extends efficiency and charging ranges beyond the reach of existing methods.

By **LEXI CARVER**

IMAGINE COMING HOME and dropping your phone, laptop, and Bluetooth® headset on your kitchen table so that they all recharge, simultaneously. Or driving your electric car into a garage, parking above a mat, and knowing it will be charged in the morning. Or being told by your doctor that there is a new medical implant to replace the one you wear—and the new version does not include power cords or the need to replace batteries.

Wireless power transfer is making these scenarios and other applications a reality by delivering a cordless way to charge electronic devices. WiTricity, a Watertown, MA-based company that develops wireless charging technology based on magnetic resonance, has launched the most consumer-friendly method available for the wireless transfer of electrical power. Invented at the Massachusetts Institute of Technology (MIT) by Professor Marin Soljacic and a team of researchers, WiTricity's technology has the ability to charge multiple devices at once, over distances and through materials like wood, plastic, granite, and glass. Companies such as Toyota, Intel, and Thoratec have already licensed the technology for use in hybrid-electric vehicles, smartphones, wearable electronics, and heart pumps.

» MAGNETIC RESONANCE WIDENS THE TRANSMISSION GAP

OTHER OPTIONS FOR WIRELESS ENERGY TRANSFER require precise device positioning on a pad or holder, very close proximity to (often resting directly on) the charging source, and the source can only charge a single device with a single coil. Now, the engineers at WiTricity have leveraged the power of magnetic resonance to rethink these limitations.

Their system, dubbed “highly resonant wireless power transfer”, relies on oscillating time-varying magnetic fields generated by alternating current passing through a coil

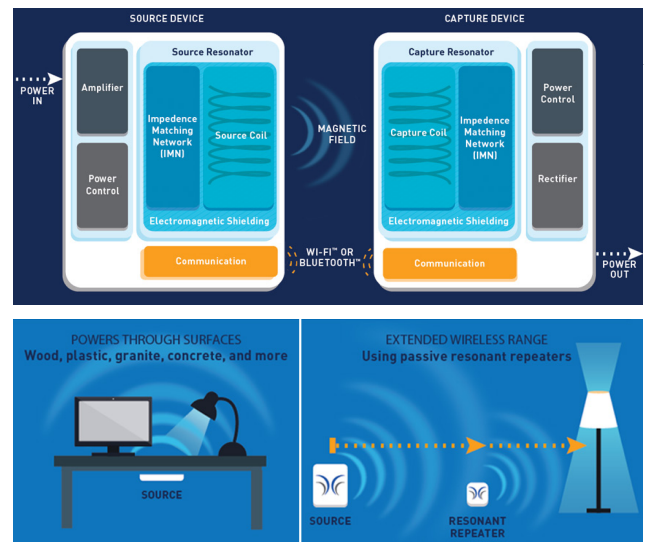

FIGURE 1: Top: Concept behind WiTricity's technology, including coils, electronics that control power output and regulation, and wireless communication between the source and capture devices to ensure the correct power output. Bottom: The technology supports charging through surfaces of different materials (left); the wireless range may be extended using resonant repeaters (right).

that functions as a power source. A power amplifier connected to this source coil controls the power levels and operating frequency, driving the magnetic field levels.

A capture device, which acts as a receiver and captures the magnetic field, contains another coil tuned to the same frequency as the source (see Figure 1).

The field converts the magnetic energy back to radio-frequency alternating current in the receiver, which can then be used as a new local power source after being rectified and regulated by power electronics.

The notable difference between WiTricity's technology and other approaches is the use of magnetic resonance. With

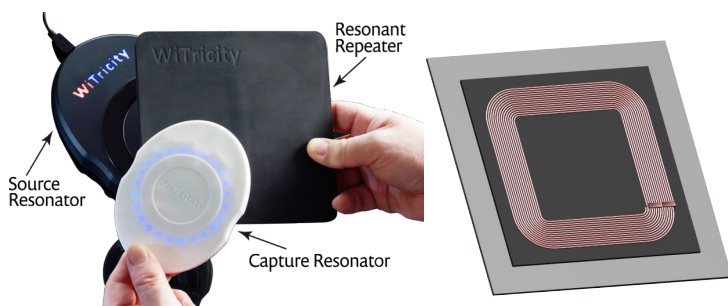

FIGURE 2: Left: A capture resonator, a resonant repeater, and a source resonator. Center: A WiTricity source resonator designed for consumer electronics applications. Right: An electric vehicle charging wirelessly, parked above a charging pad.

both coils tuned to the same resonant frequency, the receiving coil is able to capture maximum power through the magnetic field with very low losses, and power can be transmitted without the source and capture device sitting next to each other or being perfectly aligned.

“One major advantage is the flexibility of motion and positioning. The receiving coil doesn’t have to be in direct contact with the device; for instance, while driving your car you could drop your phone into a cup holder positioned near the capture device, rather than arranging it on a charging pad,” explained Andre Kurs, co-founder of WiTricity. “And you can charge everything together, including electronics that have different power requirements.”

Extending the wireless range is also easy enough: resonant repeaters that each contain another circuit and coil may be placed between the source and receiver, allowing power to ‘hop’ over greater distances (see Figure 2).

Transfer occurs effectively even with barriers (such as people and concrete walls) between the power source and the receiver.

» **MODELING THE ELECTROMAGNETICS OF WIRELESS POWER TRANSFER**

IN DESIGNING FOR MAXIMUM EFFICIENCY using coils with the same resonant frequency, Kurs and his team had to account for variables such as number of coil turns, diameter, and necessary power input. From the early stages of development, they relied on computer simulation to test key details, verify designs, and optimize the system. Using a COMSOL Multiphysics® software model, Kurs analyzed the electromagnetic and thermal behavior of different coil configurations, and was able to quickly validate new designs.

One challenge lay in making the technology scalable for a wide range of devices: a car, for instance, needs a different charging configuration than a smartphone. “We have such a wide range of applications, prototyp-

ing and testing is time-consuming and expensive, and design mistakes can set you back a lot—in such a competitive market, we can’t afford that,” he said. “Design validation in COMSOL was cost-effective and time-saving and allowed us to virtually test our concepts before building the real device.”

He created simulations with different setups for each application, and included electromagnetically relevant components such as coil windings, specially shaped ferrites and metal surfaces used to guide the electromagnetic field, plates for shielding sensitive electronics, and large objects that might perturb the field, such as a car chassis.

Then he ran a multiphysics study to analyze the resulting electromagnetic and thermal performance as a function of power drawn by the devices, coil displacements, and the effects of perturbing objects (see Figure 3, top).

He extracted circuit parameters from the results to guide the design of the electronics, as well as predictions of power dissipation and thermal loading on different components (see Figure 3, bottom). The team adjusted their designs accordingly, determining the viable range of coil displacements and power levels as a function of size, weight, and thermal constraints.

“The simulation allowed us to disentangle various

“ Design validation in COMSOL was cost-effective and time-saving and allowed us to virtually test our concepts before building the real device.”

—ANDRE KURS, CO-FOUNDER, WITRICITY

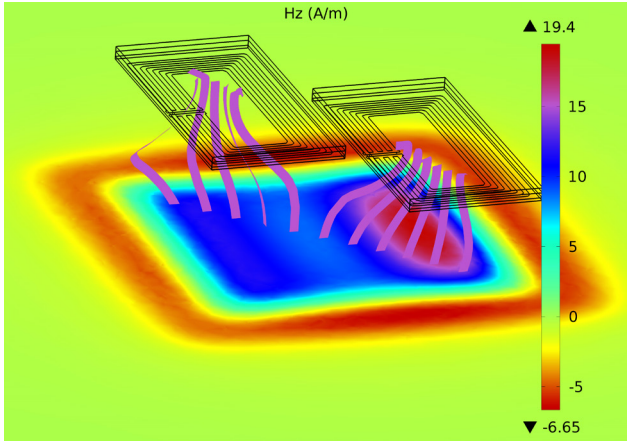

Left: Surface loss (mW/cm²), Right: Core loss (mW/cm³),

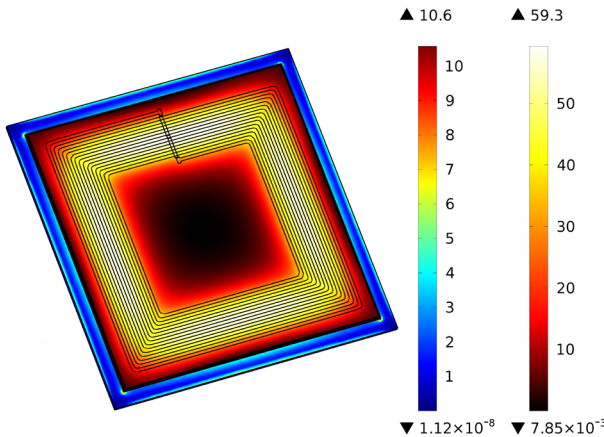

FIGURE 3: Simulation results showing the magnetic field levels (top) and power dissipated (bottom) in a source resonator for consumer electronics applications.

effects that we couldn't isolate just by testing, like power dissipation and heat transfer," Kurs remarked. "The flexibility of COMSOL was particularly useful; we built a suite of simulation apps around it that would allow any of our engineers—whether they knew how to use COMSOL or not—to quickly test and validate designs even if they didn't understand the entire model."

» KEEPING A SAFE DISTANCE, RIGHT UP CLOSE

SINCE SUCH DEVICES are near to or in contact with people's bodies, electronics manufacturers must adhere to safety limits on the electromagnetic fields emitted by their products. The magnetic fields needed for WiTricity's wireless transfer are usually fairly weak, but each new application needs to be checked for compliance.

To make sure that the field levels and resulting body temperatures would meet regulations, the team ran several more COMSOL simulations to study different body tissues in close proximity to the device. Their models calculated the electric field based on the operating frequency of the charging system, and confirmed that the results were well within FCC safety guidelines (see Figure 4).

» RETHINKING A GROWING INDUSTRY FOR WIRELESS CHARGING

WITRICITY'S DESIGNS based on magnetic resonance are a major improvement over other wireless charging methods, allowing reliable wireless power transfer in a flexible, consumer-friendly product. Thanks to their simulation work in COMSOL Multiphysics, the WiTricity team optimized their designs for better efficiency and longer ranges before building costly prototypes.

In addition to being frontrunners in game-changing wireless power transfer technology, WiTricity is on the board of the Alliance for Wireless Power (A4WP), an organization dedicated to building a "global wireless ecosystem" and creating standards for wireless charging. Another board member, Intel, has licensed WiTricity's technology to develop a wireless desk-

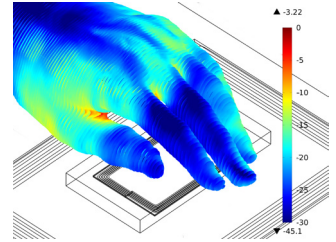

FIGURE 4: COMSOL simulation showing the specific absorption rate (SAR) in a hand above a charging cell phone. SAR is a measurement of electromagnetic energy absorbed and turned into heat. Results are in dB relative to the FCC limit (a value of zero represents the limit).

top system. The A4WP is an innovative group comprising leading companies that are ushering in a new way of thinking about wireless power: they are imagining a future where everyday surfaces—desks, cup holders, and even your kitchen countertop—become zones for charging the electronic devices we depend on so much. ©



Andre Kurs, co-founder, WiTricity.

MEDTRONIC ADVANCES ABLATION TECHNOLOGY WITH MULTIPHYSICS SIMULATION

The new technology will enhance physicians' abilities to plan and implement ablation procedures, potentially leading to better patient outcomes.

By **GARY DAGASTINE**

ABLATION, OR THE USE OF HIGH-FREQUENCY electromagnetic (EM) energy to destroy soft-tissue tumors, has been in existence for a few decades, but in recent years its underlying technology has evolved.

The benchmark of minimally invasive tissue treatment has long been the application of electrical current to kill abnormal tissues. This is done by heating tissues until they break down, a process called thermal ablation. Energy is delivered at 500 kHz, within the radio frequency (RF) range of the EM spectrum, hence these systems are called RF ablation systems.

In recent years, microwave (MW) ablation technology has also become commercially available and increasingly popular. At MW frequencies, oscillating EM fields are utilized to perform thermal ablation. Medtronic, one of the world's premier medical technology and services companies, is a leader in both RF and microwave ablation technologies.

With both RF and MW systems, the energy for ablation is applied using one or more needle-like probes.

Medtronic's latest innovation, the Emprint™ abla-

tion system with Thermosphere™ technology, offers more predictable and repeatable results than other techniques and devices (Figure 1). These advantages come from the fact that Thermosphere™ technology enables precise control of an EM field independent of the surrounding tissue environment.

» **STRIVING FOR BETTER PREDICTABILITY** ACCORDING TO RESEARCH, physicians rate predictability as their number one concern with ablation performance. The higher the

level of predictability, the easier it is for a physician to plan a treatment procedure that will be safer, more effective, and less time-consuming.

Because of its nature, it's challenging to be certain that RF ablation procedures will achieve the desired results. Given their different electrical conductivities, some tissues are less amenable to effective RF heating than others. Moreover, as the temperature in targeted tissue approaches 100°C, water in the tissue begins to vaporize and electrical conductivity rapidly decreases. This can make it difficult to generate temperatures high enough to cause cell breakdown.

MW ablation technology attempts to overcome these limitations by using an EM field radiated into the tissue (Figure 2). However, in practical application, tissue type and the vaporization of water during ablation cause the size and shape of the EM field to vary.

The Emprint™ ablation system with Thermosphere™ technology realizes the promise of predictability. It gives physicians the ability to easily control the thermal energy delivered by allowing precise control of the EM field across tissues and temperatures. This allows clinicians to accurately predict the boundaries and characteristics of the ablation zone.

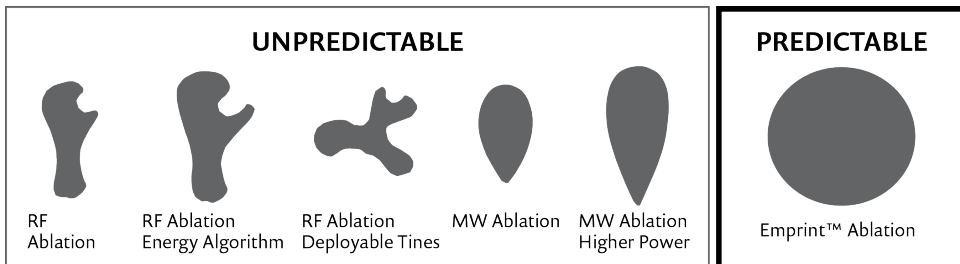

FIGURE 1: At left, shapes of tissue ablation zones that can result unpredictably from the use of various ablation technologies. At right, Medtronic's Emprint™ ablation system with Thermosphere™ technology yields predictable spherical ablations regardless of target location or tissue type.

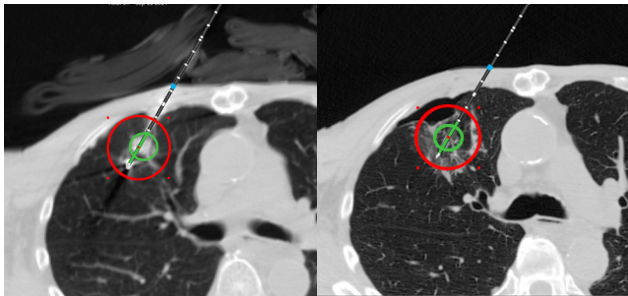

FIGURE 2: The photo at left illustrates placement of an ablation probe. The green circle delineates the target (where the lesion is located) and the red circle delineates the margin the ablation is meant to achieve. The image at right shows the site after ablation has taken place.

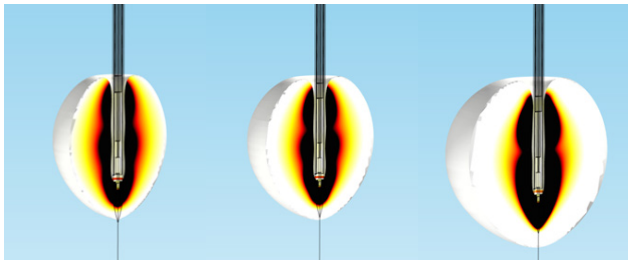

FIGURE 3: These results from a COMSOL® software simulation show the power dissipation density, or the extent of the ablation, as determined by the thermal damage calculation. The antenna and the surrounding tissue are initially well-matched, and the match (i.e., the antenna pattern) changes over time as tissue temperature increases during the procedure (left to right).

» **REAL-TIME MONITORING OF ABLATIONS**

“THE CHALLENGE NOW is to monitor the ablation performance in real-time,” said Casey Ladtkow, principal engineer in the Early Technologies unit of Medtronic’s Minimally Invasive Therapies Group (MITG). “At present, when performing ablations, physicians don’t have continuous real-time feedback on the effectiveness of their procedure. If they could know exactly what is hap-

pening in real-time from start to finish, the effectiveness of ablation treatment would increase,” he said.

With some 40 staff members focused on interventional oncology, the mission of his unit is to deliver procedural solutions that alleviate pain, restore health, and extend life. He and his team are using COMSOL Multiphysics® software to develop new ablation probes in order to achieve even higher levels of predictable perfor-

mance and effectiveness.

One development-stage project is to optimize the design of these probes so they can both create a more precise ablation zone and also provide real-time feedback using radiometers.

Radiometers measure EM radiation and enable the characterization of the spatial distribution of an EM field. Ladtkow’s team is incorporating radiometers into Medtronic probes in order to give clinicians real-time feedback about the ablation zone. This will enable a clinician to fine-tune the zone as needed during the procedure, and to make sure the radiation destroys the targeted tissues while minimizing effects on the surrounding healthy tissue.

The team uses COMSOL Multiphysics and its RF Module to help them model the probes and better understand and optimize their emitting/radiating and receiving/monitoring properties. “The performance and accuracy of MW ablation systems are affected

by a number of dynamic factors that arise simultaneously in multiple physics domains. COMSOL® software gives us the ability to perform the relevant complex modeling quickly and easily, to help us understand these coupled effects and improve our design,” Ladtkow said.

» **SIMULATION ENABLES FAST AND SAFE DESIGN, OPTIMIZATION, AND PROTOTYPING**

FOR SUCH A COMPLEX device, the traditional approach of building and evaluating a series of physical prototypes is all but out of the question because of the complexity and relationships among the many physics-based factors that impact device performance.

The team used COMSOL to model the energy radiator and test designs that incorporated radiometric sensing in the same device. They simulated coupled thermal and electromagnetic effects around the radiative probe hardware to determine radiometric performance under different conditions (Figure 3).

Ladtkow analyzed heat transfer in living tissue using a bioheat equation, which included a perfusion term, to account for blood flow cessation once the tissue coagulated (Figure 4). This helped his team understand heat transport to cells around the tumor and predict the temperature distribution to ensure efficient and predictable energy delivery.

“ Multiphysics simulation enabled the rapid development, evaluation, and optimization of our design, which would not have been possible otherwise.”

—CASEY LADTKOW, PRINCIPAL ENGINEER, MEDTRONIC

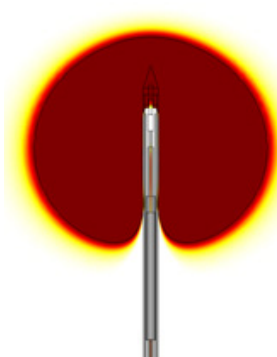

FIGURE 4: A COMSOL plot showing a cross section of the predicted ablation volume, or predicted tissue damage. This information is used to modify the bioheat equation and thereby to modify perfusion conditions in the tissue. Red areas represent coagulated tissue where no perfusion is present, and white areas represent areas of normal perfusion. This makes the model more accurate by creating a realistic on/off condition for the perfusion term in the bioheat equation.

He performed other studies as well: investigations of temperature dependence of reaction rates (to understand the size of the ablation zone); radiometry modeling to determine how much energy enters the tissue and how much is reflected back into the radiator; and liquid-to-gas phase-change dynamics (Figure 5). “The latter is critical to knowing what the wave pattern will look like, because knowing how much water is in the tissue is critical to knowing how a radiometer will behave, because of the change in wavelength,” he said. “Implementing this model in COMSOL is straightforward.”

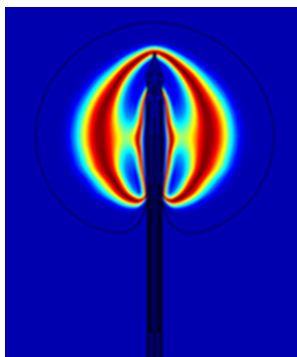

FIGURE 5: COMSOL results show the change in heat capacity in the tissue surrounding the probe, dominated by phase change of water in that tissue. Knowing where water is boiling is important because the MW radiation wavelength is dramatically different for liquid water than for vaporized water.

Simulation showed that lengthening the proximal radiating section (PRS) and shortening the distal radiating section (DRS) of an antenna would produce an efficient ablation radiator and an efficient receiver. These studies (Figure 6) resulted in versions of a prototype ablation radiator with an integrated radiometer, along with results showing the performance of the integrated probe.

» FROM IMPOSSIBLE TO POSSIBLE

“WITHOUT COMSOL to help us perform these analyses, it simply would be impossible to do enough experiments to find an optimum solution that integrates an emitter and a receiver. COMSOL helps us see that certain architectures—which we’d never have investigated otherwise—might make an

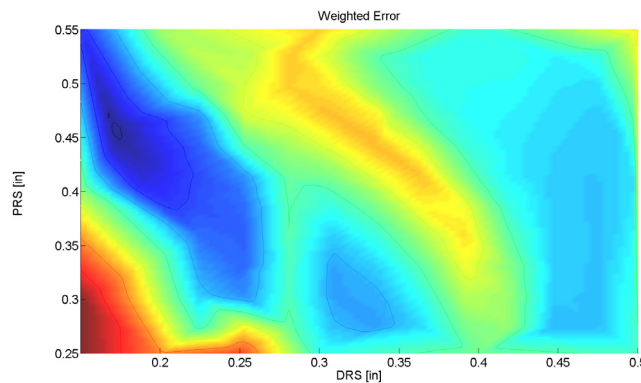

FIGURE 6: A COMSOL weighted error plot. Blue areas indicate regions where reflected power is low for delivered ablation energy and also where the receiver quality is good. They represent antenna configurations that are both good ablation devices and good radiometers.

integrated device possible,” Ladtchow continued.

His team uses COMSOL® software in conjunction with MATLAB® software, and he said that the combination gives him a powerful ability to optimize complex models with highly sophisticated algorithms quickly and easily. He also hopes to integrate the Application Builder available in COMSOL Multiphysics into their modeling workflow. This would enable the team to create simulation apps allowing partners

to test and verify different designs, while protecting their proprietary models.

“Based on our simulations, we are now realizing the potential to introduce ablation devices that will allow clinicians to not only deliver a precise energy dose, but also monitor ablations in real time,” Ladtchow said. “Multiphysics simulation enabled the rapid development, evaluation, and optimization of our design, which would not have been possible otherwise.”



From left: The Medtronic team consists of Morgan Hill, Casey Ladtchow, and Robert Behnke.

GRAPHENE PAVES THE WAY FOR NEXT-GENERATION PLASMONICS

Simulation tools bring the complex physics of two-dimensional materials and plasmonics together in a way that could change the face of optoelectronic devices.

By **DEXTER JOHNSON**

EVER SINCE A SINGLE-ATOM-THICK FILM of graphite was first successfully synthesized back in 2004 and called graphene, it has been on a decade-long ride through applications ranging from photovoltaics and next-generation batteries to electronics.

While graphene's list of desirable properties—like its electrical and thermal conductivity—initially made it attractive for electronics, its equally attractive optoelectronic capabilities were initially overlooked. But it soon became clear that graphene has incredible potential as a transparent conducting electrode and could be an alternative to the commonly used indium tin oxide (ITO). Graphene offers comparable or better optoelectronic performance in addition to its mechanical strength and flexibility. Other potential uses are diverse and include applications such as transparent conductors used in touchscreens and photovoltaics (see Figure 1), lab-on-chip devices for the sensing of viruses or proteins, improved night vision, mid-IR imaging applications, and solar cells.

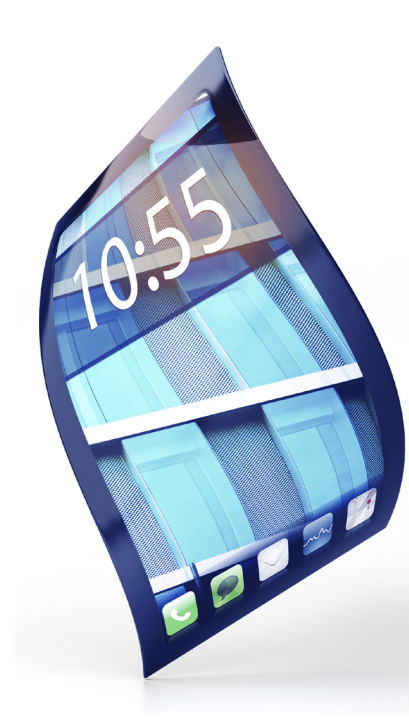

FIGURE 1: Bendable and lighter smartphone and laptop screens are just one of the many applications of graphene. Others include energy, computing, engineering, and health technologies and devices.

» GRAPHENE AND PLASMONICS MEET

IN ADDITION TO OPTOELECTRONICS, graphene's star has shone particularly bright in photonics when it is used in combination with the field of plasmonics, a subfield of photonics that grew out of the need to continually explore properties and applications of light on ever-smaller scales.

Traditionally, photonics has dealt with structures on the micrometer scale, but squeezing light into smaller dimensions is fundamentally challenging due to a property of light known as the diffraction limit. Plasmonics helps with addressing this challenge and enables light confinement even at the nanoscale.

This is achieved by coupling incident light into oscillations of electrons known as plasmons—hence the name plasmonics. Today, plasmonics is an important, actively developing branch of photonics that deals with the efficient excitation, control, and use of plasmons.

» GRAPHENE-ENABLED PLASMONICS IS LEADING TO PRACTICAL DEVICES

COMPUTATIONAL NANOPHOTONICS efforts at Birck Nanotechnology Center, Purdue University, led by Alexander V. Kildishev, associate professor of electrical and computer engineering, have been leading the way in combining graphene with plasmonics to bring it closer to practical optoelectronic applications.

The work of Kildishev and his colleagues deals with a fundamental problem in graphene research: it is currently difficult to fabricate high quality, large-area graphene films. Until graphene production improves, Kildishev and his team are leveraging simulation tools to perform design and optimization of devices made from graphene.

Through both simulation and experimental testing, Kildishev and his colleagues have been able to dem-

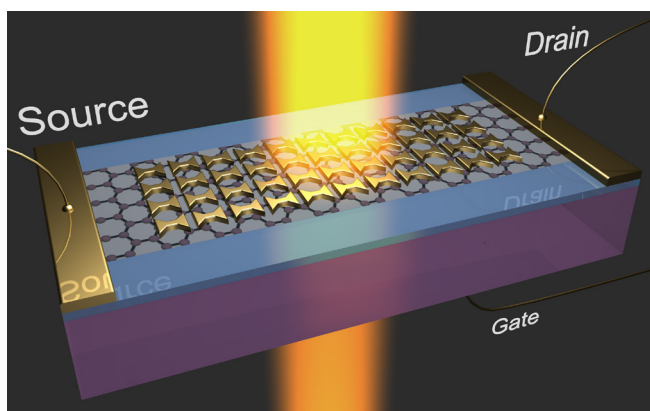

FIGURE 2: Design of Fano resonant plasmonic antennas on top of a single-layer graphene sheet optimized with COMSOL® software and its Wave Optics Module to achieve resonance at a 2 μm wavelength. The design tunability has been successfully validated in experiments using ion-gel top electrolyte gating².

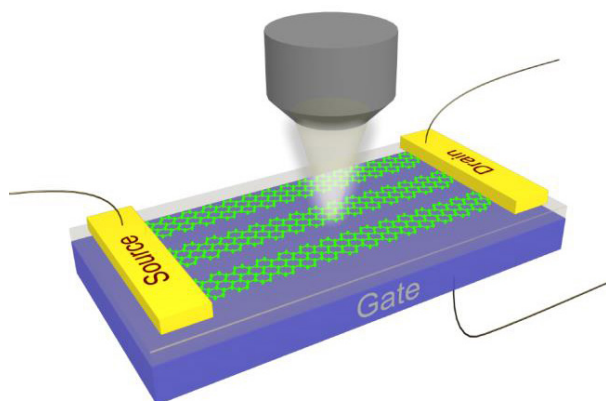

FIGURE 3: 3D artistic sketch of the experimental setup used for studying plasmon resonance in graphene nanoribbons (GNRs), simulated with COMSOL Multiphysics® software using the surface current approach. The lattice orientation of GNRs is for illustration only and dimensions are not to scale.

onstrate tunable graphene-assisted damping of plasmon resonances in nanoantenna arrays, which is important for designing tunable photonic devices in the mid-infrared range¹. Since the mid-infrared is where fundamental vibrational resonances reside for a wide range of molecules, it is critical to have tunable plasmonic devices that work in that range for applications in sensing and imaging.

On the other hand, moving closer to even shorter infrared (IR) waves, e.g., the telecom range, is also of ultimate importance for telecommunications and optical processing. The group at Purdue has shown efficient dynamic control of Fano resonances in hybrid graphene-metal plasmonic structures at near-infrared wavelengths. Fano resonances are seen in the transmission of specifically coupled resonant optical systems. Researchers are currently leveraging the properties of Fano resonances for use in optical filtering, sensing, and modulators (see Figure 2).

Leveraging the predictive power of COMSOL Multiphysics® software models is a vital step for designing tunable elements for the next generation of plasmonic and hybrid nanophotonic on-chip devices such as sensors and photodetectors, according to Kildishev. The photodetec-

tors could ultimately find use in the sensing of infrared electromagnetic radiation for multicolor night vision and thermal imaging. Another application may be in biosensing, where the resonant lines of plasmonic elements are tuned to match the resonances of the spectral optical responses of viruses or proteins.

In their work, the Purdue researchers combined the unique properties of graphene with plasmonic nanoantennas to modulate the antenna's optical properties. Having a tunable resonant element along an optical path is as critical to optoelectronics as having a transistor in an electric circuit.

“By using the nanopatterned graphene with an electrical gating (see Figure 3), it’s possible to modulate light flow in space with unparalleled spatial resolution,” said Dr. Naresh Emani, a former Ph.D. student advised by Kildishev, now with DSL, Singapore. “The reduced dimensionality and semimetallic behavior of graphene plasmonic elements gives us, along with its other properties, a very vital feature—electrical tunability. This critical functionality is not attainable with conventional metal plasmonics.”

Plasmonic devices based on noble metals lack this level of control over electrical tunability. Noble metals possess a large number of elec-

trons in the conduction band, and consequently the electrical conductivity of metals cannot be easily modulated. But since graphene is a tunable semimetal, it does not contain any electrons in the conduction band in its pristine state. Therefore, its electron concentration—and hence its electrical conductivity—can be tuned chemically, modulated electrically, or even modulated optically.

» THE ROLE OF SIMULATION AND MODELING

NUMERICAL MODELING has been a critical tool for the researchers, allowing them to optimize their designs without complications and the significant cost of nanofabrication processes.

“Compared to experimental work, mathematical modeling is low-cost, has the opportunity to validate its output through a reduced number of prototypes, has predictive power, and, finally, allows you to optimize for a desired functionality,” explained Kildishev.

In a field where the quality of the graphene material can vary, it is critical that there always be a tight connection between numerical results and experiments in order to better understand the impact of all variables involved.

“In most cases, by fitting model

parameters to experiments, we can retrieve the actual physics of a given process,” said Kildishev. “Having a validated mathematical model in hand always provides better understanding and interpretation. Once you understand the phenomena in terms of a mathematical model, you gain comprehensive knowledge of the whole mechanism that can be applied to other new ideas.”

Of course, mathematical modeling has its own barriers. “Unfortunately, many problems do not have analytical solutions and we must revert to alternative options,” he added.

This is where numerical techniques come in as powerful tools for circumnavigating these hurdles, according to Dr. Ludmila Prokopeva, a high-performance computing specialist on Kildishev’s team. Properly designed simulation tools provide stability, accuracy, and speed. There is often a need for substantial high-performance computational machinery, especially for nanostructured devices that require full three-dimensional (3D) simulations.

“The multiphysical and multiscale essence of computational nanophotonics necessitates the use of powerful simulation tools,” said Kildishev.

It is never one simulation tool that works in all situations. “We have a whole zoo of our own software and commercial software, and we are always looking for ways to incorporate new and interesting physics,” said Kildishev. “COMSOL Multiphysics is one tool that we have relied on for about ten years, and its key advantage is its flexible operation within its unique equations-driven framework, which is unparalleled.”

He added: “COMSOL allows users to couple several physics interfaces sharing the same mesh or even having separate meshes. We can also link the solvers to complex material

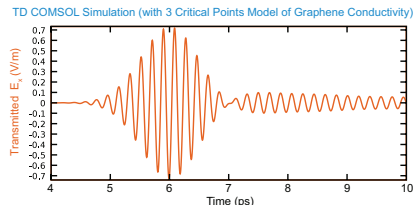

FIGURE 4: The time-dependent electric field of a Gaussian pulse transmitted through an array of graphene nanoribbons.

functions: for example, my team has implemented several complex dielectric models for graphene—written in MATLAB® software—which are seamlessly incorporated using COMSOL® software. Some of these dielectric functions are impossible to handle for a straightforward explicit input in terms of plain arithmetic or look-up tables. We are also able to introduce nonlinear effects, couple these to a heat transfer analysis, add quantum emitters—the list goes on.”

“Another strength of COMSOL is its capability to model two-dimensional (2D) materials natively in terms of surface conductivity (i.e., surface current),” noted Prokopeva. “Because of its atomic thickness, graphene behaves like a 2D material, but many researchers use a thin artificial thickness and have to resort to a 3D model in their simulations just because of the inability to treat 2D materials naturally in their software. The 3D approach brings unphysical shifts, uncertainty in optimization procedures, and significant complications to the numerical calculations.”

While waiting for manufacturing techniques to mature, the Purdue team used a theoretical model for graphene’s optical conductivity and simulated the device response in COMSOL to numerically investigate the system properties (see Figures 2 and 4).

“We’ve been very fortunate to collaborate with our ‘next-door’ exper-

iment-oriented teams of Profs. Yong Chen, Alexandra Boltasseva, Vlad Shalaev, Ashraf Alam, David Janes, and Gary Chen, here at the Birck Nanotechnology Center at Purdue. Collaboration with the Ted Norris and Vinod Menon groups within the C-PHOM NSF MRSEC center is also of critical importance. As the experimental studies are focused on very diverse facets of novel graphene applications, including IR sensors, hybrid photovoltaic electrodes, and even other 2D materials, they give us an excellent base for validating our new modeling approaches. They offer indispensable feedback from the fabrication and optical characterization of real-life graphene-based nanostructures.”

» LOOKING AHEAD TO QUANTUM OPTICS, BETTER NIGHT VISION, AND FLEXIBLE TOUCHSCREENS

THE PURDUE TEAM is continuing their simulation work to understand and predict the behavior of graphene so that it may be put to use in devices such as photovoltaics, optical modulators, and—one day—flexible touchscreens. They are looking to make graphene nanoribbons so that they can begin fabricating a preliminary light modulation device^{3,4}.

“Generation and modification of short optical pulses is an important aspect of imaging and sensing,” explained Kildishev. “Currently, the devices capable of achieving this functionality at mid-IR wavelengths are rather bulky and are not tunable. We envision a prototype device that can dynamically change the frequency content of an incoming optical pulse or light beam. This will enable higher sensitivity detection for night vision and mid-IR imaging applications.”

They also have longer-range aspi-

“Another strength of COMSOL is its ability to model two-dimensional materials natively in terms of surface current.”

—LUDMILA PROKOPEVA,
HIGH-PERFORMANCE
COMPUTING SPECIALIST, BIRCK
NANOTECHNOLOGY CENTER

rations to explore the plasmonic properties of graphene in the quantum optics regime. Kildishev and his colleagues believe the quantum optics regime will be the next frontier for the science of light and has been relatively unexplored in the mid-IR wavelengths.

“Semiconductor quantum wells show some interesting quantum properties but are restricted to low temperatures so far,” said Kildishev. “If we successfully address some of the challenges in graphene research, it might end up outperforming semiconductor quantum wells. If we are able to do this, we could significantly reduce the size of many devices.” They continue to move forward on the cutting edge of research with many unknowns, toward a future that contains unbelievable possibilities. ©



Alexander V. Kildishev, associate professor at Purdue's Birck Nanotechnology Center.

References

- ¹ N. K. Emani et al., *Nano Lett.* 12, 5202–5206 (2012).
- ² N. K. Emani et al., *Nano Lett.* 14, 78–82 (2014).
- ³ D. Wang et al., “Plasmon Resonance in Single- and Double-layer CVD Graphene Nanoribbons,” in *CLEO: 2015*, p. FTu1E.3.
- ⁴ L. Prokopeva and A. V. Kildishev, “Time Domain Modeling of Tunable Graphene-Based Pulse-Shaping Device (invited),” in *ACES 2014*.

SIMULATING GRAPHENE

BY ANDREW STRIKWERDA

WHAT IS THE BEST WAY to simulate graphene? More specifically, should graphene actually be modeled as a 2D layer or rather as a 3D material that is extremely thin? Many researchers have used the latter approach because it is the only one supported in their numerical software. With COMSOL Multiphysics® software, you can use either method. As stated in the article, Professor Kildishev and his colleagues have found that simulating graphene as a 2D material yields better agreement with experimental results. Let's take a closer look at how this is implemented in COMSOL® software.

Ohm's law states that, in the frequency domain, the current density is simply the product of the conductivity and the electric field:

$$J = \sigma E$$

In COMSOL Multiphysics, this can be implemented in 2D using a Surface Current boundary condition where the induced current is expressed, according to Ohm's law, as the product of the graphene conductivity (calculated, for example, from a Random Phase Approximation) and the tangential electric field.

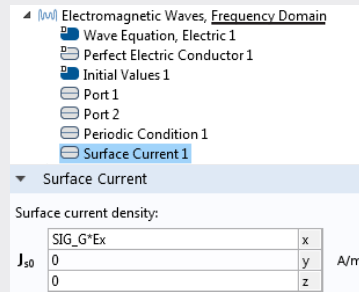

For time-domain simulations, the required surface current density can be a little more difficult to calculate, since Ohm's law is now a convolution of the electric field and the conductivity:

$$J(t) = \int_{-\infty}^t \sigma(t - \tau) E(\tau) d\tau$$

To implement this in COMSOL (see Figure 4), Professor Kildishev's group used a Padé approximation to represent the frequency-dependent optical conductivity of graphene. They then applied a Fourier transform of the terms in the Padé series to obtain second order partial differential equations in time, which can be solved in COMSOL.

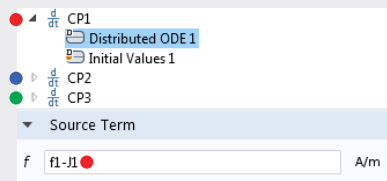

The solutions to these equations, representing contributions to the time-dependent surface current, can then be linked to the Surface Current boundary condition.

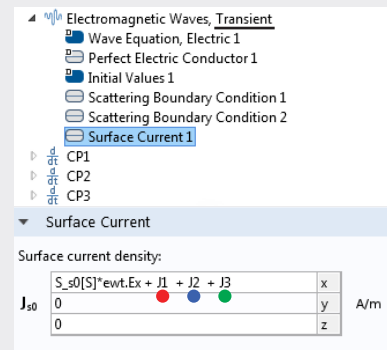

If you would like to learn more about how to simulate graphene, watch the webinar by Alexander Kildishev on comsol.com/webinars and download his COMSOL models available at comsol.com/community/exchange/361.

DEFYING CONVENTION TO ACHIEVE FASTER SIGNAL AND SIMULATION SPEEDS

Innovative optimization methods combining space mapping algorithms and electromagnetic simulation make it possible to improve signal speed and integrity in package interconnects. Faster simulations ensure the latest high-speed interconnect technology is available in less time.

By **JENNIFER SEGUI**

ESTABLISHED AS LEADERS in the electronics and computer hardware industry, it is easy to assume that the researchers and engineers at Intel rely on powerful computing clusters and servers to efficiently simulate and optimize their designs. While we would be correct in our assumptions, there's much more to their methods. Multiphysics simulation software and an unconventional approach to design optimization developed at the Intel Guadalajara Design Center may be behind the latest high-speed interconnects for electronics packaging.

Take printed circuit boards (PCBs), for example. A mainstay in electronics packaging, PCBs are found in almost every electronic device from handheld computers and cellphones to state-of-the-art satellite communication systems. PCBs have many integrated high-speed interconnects enabling the transfer of electronic signals between components that are attached at the surface. To demonstrate, a PCB research prototype is shown in Figure 1, where probes are in contact with surface traces at each end of a package interconnect.

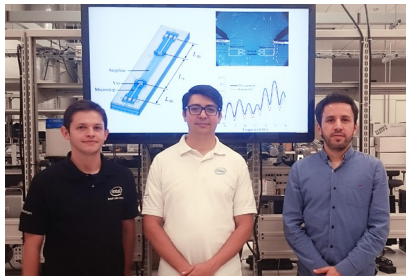

Engineers from the Intel Guadalajara Design Center, pictured from right to left, are: Juan C. Cervantes-Gonzalez, Carlos A. Lopez, and Isaac G. Farias-Camacho.

In making electronic devices smaller, the size and spacing of package interconnects is scaled down by necessity, which can make computational design optimization to improve signal speed and integrity more time consuming.

Interconnects operating at higher frequencies—or signal speeds—will also consume more power. The geometry and materials of package interconnects have to be redesigned to minimize power consumption and prevent signal loss for a given application, which applies particularly well in the case of PCBs given their range of uses.

“Using simulation to optimize the design of package interconnects is

essential, requiring accurate models that capture the non-negligible couplings arising from complex 3D structures,” explains Juan C. Cervantes-González, an engineer at Intel. “To make electromagnetic simulations of package interconnects even faster, we have exploited and validated a space mapping optimization algorithm. With this optimized approach to simulation, we can further decrease the length of the design cycle and time to market of the latest, high-speed interconnect technology.”

» MODELING HIGH-SPEED PACKAGE INTERCONNECTS

FULL-WAVE ELECTROMAGNETIC SIMULATION is necessary to model signal propagation in package interconnects operating at higher frequencies. By solving the complete set of Maxwell's equations without any simplifying assumptions, simulations can accurately account for non-negligible electromagnetic couplings and impedance mismatch in complex 3D structures, important contributors that cause crosstalk and reflection compromising signal integrity.

Using COMSOL Multiphysics® software, the engineers at Intel developed a model of a single-ended interconnect line embedded in a PCB structure. A cross section of the model geometry is shown at left in Figure 2, and highlights the relevant design parameters that are optimized in their work.

Single-ended interconnects are

“With this optimized approach to simulation, we can further decrease the length of the design cycle and time to market of the latest, high-speed interconnect technology.”

—JUAN C. CERVANTES-GONZALEZ, ENGINEER, INTEL

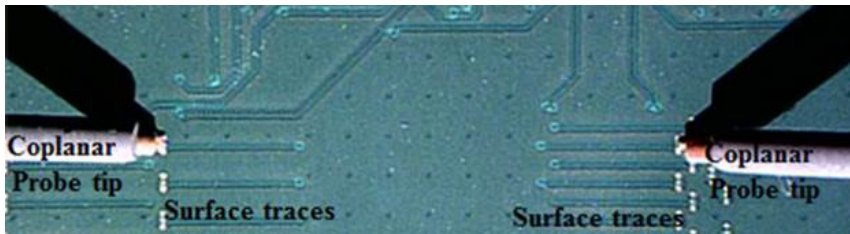

FIGURE 1: An Intel PCB research prototype featuring package interconnects.

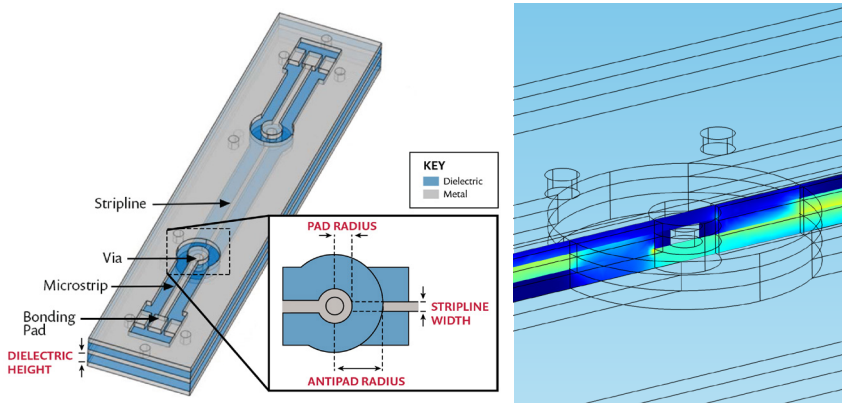

FIGURE 2: Left: Model geometry of a single-ended interconnect set up in COMSOL Multiphysics® software. Parameters highlighted in red are optimized using simulation. Right: Electric field distribution through a via in the modeled package interconnect.

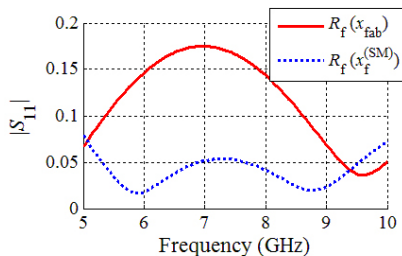

FIGURE 3: Magnitude of the reflected signal ($|S_{11}|$) obtained by solving the fine model. Significant reflection is observed for the design parameters of the fabricated interconnect prototype (red curve) compared with the space-mapped optimized solution (blue curve).

known for their high signal speeds and for taking up less space in electronics packaging, enabling their use in densely packed layouts. Signals propagate laterally through interconnects along metallic microstrips and striplines with ground planes separated by dielectric material. Signals travel vertically through vias, often traversing more than 10 layers of dielectric and metal in a typical PCB,

making them the primary culprits contributing to impedance mismatch.

In COMSOL® software, full-wave electromagnetic simulation is used to optimize the geometric parameters of a fabricated prototype in order to minimize impedance mismatch and the resulting signal reflection or return loss. Simulation results showing the electromagnetic field distribution in a single-ended interconnect are presented at right in Figure 2.

» OPTIMIZING INTERCONNECTS FOR LOW RETURN LOSS

TO OPTIMIZE THE DESIGN of high-speed package interconnects and minimize the magnitude of the reflected signal over a range of frequencies, simulations are run on a high-performance server with dual Intel® Xeon® X5670 CPU at 2.93 GHz and 160 GB of RAM. To make simulations run even faster, a Broyden-based input space mapping optimization algorithm was implemented.

The space mapping approach to

electromagnetic simulation involves solving two separate interconnect models in COMSOL. The first is a “coarse” model and is a 2D simplification of the model geometry in Figure 2, which neglects electromagnetic losses and is discretized using a very coarse mesh designed to provide a fast result. The second is a “fine” model whose topology is identical to the first, but represents the full 3D geometry shown in Figure 2 and is solved using a much finer mesh, providing greater accuracy at the cost of speed.

The signal response for the optimal 2D model design was determined first using conventional optimization methods, and is an important first step that reduces the overall computation time. The objective of the space mapping algorithm, implemented in MATLAB® software, is to find the 3D model design parameters that make its resulting signal response close to the optimal 2D model response. Using this method, the interconnect design parameters are optimized within just four iterations. The results in Figure 3 were obtained by solving the full 3D model, and show a significant reduction in reflected signal for the optimized design compared with the original fabricated interconnect prototype.

“By using full-wave electromagnetic simulation along with space mapping optimization, a much better interconnect design is achieved with lower return loss, and in far less time than it would take to make and test many different prototypes,” says Cervantes.

Although their initial model only solved for electromagnetic wave propagation in order to validate the space mapping optimization method, heat transfer and solid mechanics can also be included in fully coupled multiphysics models providing innovative, if not unconventional, design capabilities. ☺

INCREASING LIFESPANS OF HIGH-POWER ELECTRICAL SYSTEMS

Using a combination of experimental testing and multiphysics simulation, researchers at ABB Semiconductors have redesigned the insulated-gate bipolar transistor modules (IGBT modules) used in high-power electrical components to increase device lifetime.

By **DEXTER JOHNSON**

THE HIGH-POWER electrical systems found in locomotives must be able to withstand the enormous amounts of stress brought on by the high currents and voltages surging through them. At the heart of these electrical systems are insulated-gate bipolar transistors (IGBTs), electronic switches that are used because of their high efficiency and fast switching to deliver power to locomotive systems. As a train travels from one station to the next, IGBT power modules are exposed to repeated electrical, thermal, and mechanical fatigue, which can degrade the module and cause failure.

“Typically, traction motors for driving locomotives are designed so the devices can withstand the harsh load profile for 30 years,” explained Samuel Hartmann, principal R&D engineer at ABB Semiconductors in Lenzburg, Switzerland. If the IGBT modules wear out during the lifetime of the traction motor, they must be replaced. In order to meet the requirements of the traction motor’s long lifetime and boost the reliability of these systems, Hartmann and his colleagues are leveraging computer simulation to better understand

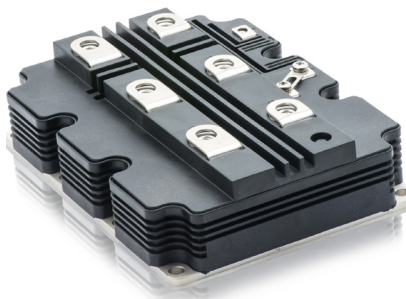

FIGURE 1: ABB HiPak power module with rated blocking voltage of 6500 V and nominal current of 750 A.

how the power cycling performance of IGBT modules can be increased.

“Our team is looking into ways to improve the performance of ABB’s HiPak power modules,” said Hartmann (see Figure 1). “The modules are composed of many paralleled IGBT chips, which, in their ‘on’ state, can conduct high levels of current, and in their ‘off’ state can resist very high voltages.” The modules are also used for applications such as industrial drives and renewable energy.

“During use in a locomotive, IGBT power modules are exposed to high temperatures, and as a result, the

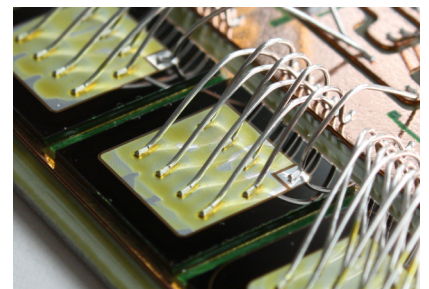
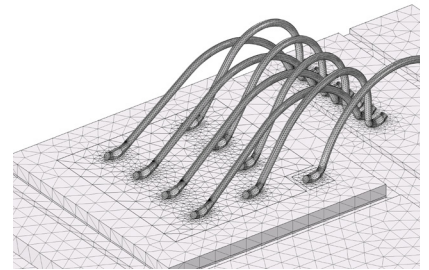

FIGURE 2: Top: The meshed COMSOL® software model of the reference wire bond layout. Bottom: Photo of the reference emitter.

“joints between different components can degrade due to thermo-mechanical stress,” described Hartmann. “After the weakest bond fails and the wire pulls away from the emitter, electrical contact is lost and the remaining wire bonds interconnecting the semiconductor device and its package-

ing must conduct higher currents. This eventually results in a cascading failure as the thermo-mechanical stress in the remaining bonds increases. If we can strengthen the weakest joint, then we can increase the overall lifetime of the device.” By increasing the HiPak power module’s usable lifetime, ABB can reduce the number of modules needed to reach the 30-year lifetime typically required of these

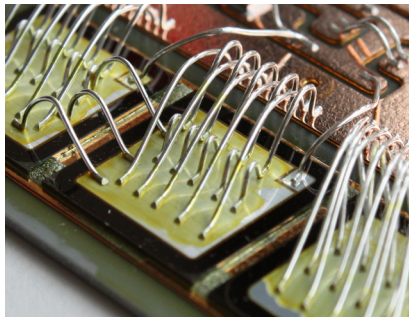
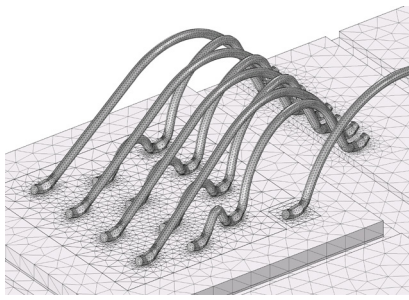

FIGURE 3: Top: The mesh of the stitch-bonded wire bond layout. Bottom: Photo of the stitch-bonded layout now used in some of the HiPak power modules.

motors, thereby saving resources and reducing the time needed for repairs.

» SIMULATIONS BRING CLARITY TO EXPERIMENTAL RESULTS

ABB’S HIPAK POWER modules typically consist of a baseplate, circuit boards, IGBT and diode chips, wire bonds, and conductor leads. In order to increase the lifetime of the power module, Hartmann explored a few different ways to increase the durability of the wire bond connections from the circuit board to the emitter bond pad.

“We explored two different methods for improving the design,” described Hartmann. “In one case, we looked at different ways the wires were connected to the emitter to see if stitched bonding techniques could prevent component degradation and extend device lifetime.” The meshed models and photos of the device for the commonly used reference wire bond layout and the stitch-bonded layout are shown in Figure 2 and Figure 3, respectively.

“For the second case, we used new joining techniques to bond a stress buffer between the emitter’s silicon chip and the aluminum wire bonds,” Hartmann continued. “The coefficient of thermal expansion (CTE) of the stress buffer is between the CTE of silicon and aluminum, and thus results in reduced

“ Experimentally, we have assessed several variants of these wire bond connections and used multiphysics simulation to understand why one variant is better than the other.”

—SAMUEL HARTMANN,
PRINCIPAL R&D ENGINEER, ABB
SEMICONDUCTORS

thermal and mechanical loading.”

The ABB team leveraged multiphysics simulation to gain a better understanding of the underlying mechanisms at play in the deterioration of the IGBT chips, such as the electro-thermal and thermo-mechanical response of different designs when exposed to repeated power cycling tests. “The higher the power cycling capability, the more durable and reliable the design,” explained Hartmann.

“Experimentally, we have assessed several variants of these wire bond connections and used multiphysics simulation to understand why one variant is better than the other.” Hartmann believes that ABB’s use of the COMSOL Multiphysics® simulation software was key to the success of their design.

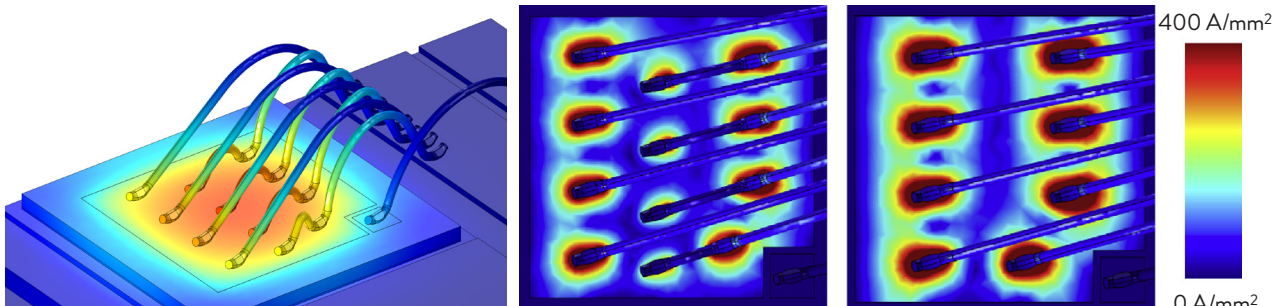

FIGURE 4: Left: COMSOL results showing the temperature distribution obtained for the stitch-bond layout. Right: Current density in the stitch-bonded and reference layout showing the reduction in current around the wire’s feet for the new design.

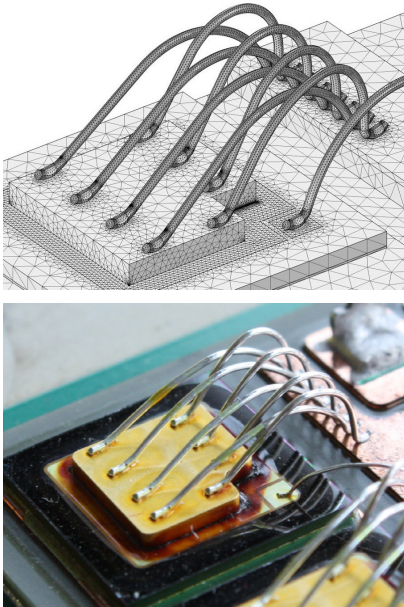

FIGURE 5: Top: The mesh of the reinforced emitter contact. Bottom: Photo of the reinforced emitter contact.

» EXPLORING DIFFERENT IGBT MODULE DESIGNS WITH SIMULATION

IN A FIRST EXPERIMENT, the ABB team tested two different bonding techniques: the reference wire bond layout (see Figure 2), and the stitch-bonded layout, where the wire is bonded to the surface of the chip more than once (see Figure 3).

Using simulation and experimental testing, Hartmann compared three different stitch-bonded layouts to the reference layout. “As expected, we found that, with more wire bonds on a single chip, the current density within the wires, especially at their feet, was also reduced,” described Hartmann. “And thanks to simulation, we gained an unexpected insight: the stitch-bonded layout did not reduce temperature gradients or mechanical stress: the improved performances are due to the current density reduction resulting from

a lower current density in the chip’s metallization around the bond feet.”

The additional bonds provide more locations for current to pass through the wires, therefore decreasing the amount of current dissipated by each wire (see Figure 4). “The new bond layout resulted in an IGBT design that has a power cycling capability that is four times higher than the reference layout. This new design is now being used in some of our HiPak power modules.”

For a second experiment, Hartmann and his colleagues compared wires bonded directly on the chips with wires bonded to a metal plate attached to the chip that serves as reinforcement for the emitter (see Figure 5).

Using simulation, Hartmann found that for the reinforced emitter contact, the current density, the temperature variation, and the mechanical stress experienced by the wires at the bond interface was much lower than in the reference module (see Figure 6). This resulted in wire bonds that were

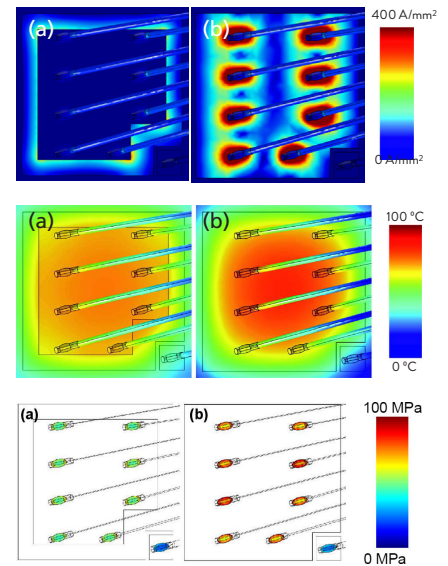

FIGURE 6: From top to bottom: Results from ABB’s COMSOL model showing the simulated current density, temperature variation, and von Mises stresses at the bond-to-chip interface for the (a) reinforced and (b) reference emitter contacts on the front metallization and wire bonds.



Emre Oezkol (left) and Samuel Hartmann (right), holding the circuit board and the HiPak power module, respectively.

“In the IGBT modules that were reinforced, we saw that the wire bonds showed a cycling performance that was ten times that of the standard modules. With simulation we were able to verify that the mechanical stress was reduced, and this explained the dramatically increased durability.”

—SAMUEL HARTMANN

less likely to detach from the emitter.

“In the IGBT modules that were reinforced, we saw that the wire bonds showed a cycling performance that was ten times that of the standard modules,” said Hartmann. “With simulation we were able to verify that the mechanical stress was reduced, and this explained the dramatically increased durability.”

» INCREASED LIFETIME FOR IGBT POWER MODULES

THE RESULT OF THE WIRE bond simulations and the new joining techniques has resulted in the lengthening of the lifetimes of ABB’s power modules by a factor of 4 for the stitch-bonded layout and a factor of 10 for the reinforced emitter contact. This improved lifetime translates into higher power output per device, which in turn leads to lowering costs for ABB’s power module customers.

“If the power cycling capability is increased, as in the case of the improved wire bond layout now available in our new modules,” explained Hartmann, “then a lower number of power modules are needed to reach the 30-year lifetime of a traction motor, which is the standard in the traction industry. This directly reduces the cost of a locomotive and enhances the competitiveness of our power modules.” ©

JOULE HEATING AND THERMAL EXPANSION

BY HENRIK SÖNNERLIND

AN ELECTRIC CURRENT WILL generate heat through resistive losses, an effect called Joule heating. Since the resistivity usually has a strong dependence on the temperature, the heat transfer problem and the electrical problem must be solved simultaneously in order to accurately find the temperature and current distribution.

As an effect of the heating, thermal expansion will induce deformations. Large strains and stresses may then occur for several reasons. Deformations in materials with different coefficients of thermal expansion will not be compatible with each other; and there may also be large temperature gradients within a single material.

There are also certain cases where heat distribution is affected by structural deformations. For example, when objects come into contact with each other or large deformations cause changes in the electrical or thermal boundary conditions, a dramatic shape change occurs. If the heating cycle is repeated, the corresponding stress and strain cycles will be repeated as well. This may ultimately lead to a fatigue failure of the material.

In COMSOL Multiphysics® software, you can directly combine all these effects by selecting *Joule Heating and Thermal Expansion* in the list of available *Structural Mechanics* physics interfaces.

When doing so, the three contributing physics interfaces (*Solid Mechanics*, *Heat Transfer*

in Solids, and *Electric Currents*) are added to the application, along with the necessary multiphysics couplings added through the *Multiphysics* node.

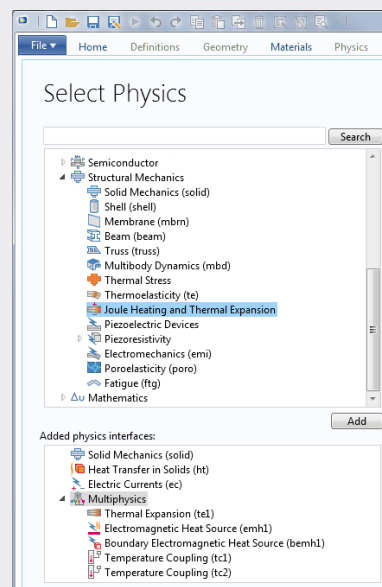

You can then choose settings for how to solve for the three physics interfaces. One approach would be to solve for the electric currents and temperatures together in a time-dependent study, and then solve the structural mechanics problem as stationary. Since the highest stresses could appear at any time during the thermal cycle, it is necessary to check stress values at several time steps.

For a qualitative comparison, it is sufficient to look at the computed stresses, but adding a *Fatigue* interface would make it possible to also make lifetime predictions.

BRINGING GLUCOSE MONITORING TO NEW LEVELS THROUGH INTEGRATED SENSOR DESIGN

Researchers and designers at Roche Diagnostics are developing glucose sensors with greater measurement accuracy for diabetic care, aided by multiphysics simulation.

By **LEXI CARVER**

CLOSE METABOLIC CONTROL through glucose monitoring is a well-known way for persons with diabetes to maintain good health and avoid medical complications. The current generation of glucose monitors relies on electrochemical methods to facilitate unprecedented measurement accuracy, and has given diabetics a reliable way to control their diet and insulin intake.

However, the chemical reactions that take place on the sensing strips used in glucose monitors are sensitive to environmental conditions and chemical interferences. Sensors are shipped worldwide, stored under uncertain conditions, and needed by users with different levels of knowledge and experience. Robust design is crucial for enabling sensors to survive these environments, deliver accurate results, and detect conditions that would cause errors. Now multiphysics simulation is used alongside experiments and calculations, enabling scientists to understand the chemical, electrical, and biological phenomena interacting in these systems so they can optimize their design and measurement methods.

» GAINING GROUND WITH A NEW KIND OF SENSOR

ENGINEERS AT ROCHE DIABETES CARE, a worldwide leader in diabetes diagnostic products and services, are currently pursuing a better understanding of the electrochemistry in their existing devices and are designing new sensing methods to provide more accurate monitoring. Like other amperometric biosensors, their glucometers (an example is shown in Figure 1) measure the electric current that results when a voltage is applied to an electrode system. The resulting current is proportional to the glucose levels in an electrolyte solution (such as a blood sample combined with a chemical reagent).

A set of gold traces lie on each glucose test strip, run-



FIGURE 1: Photograph of an ACCU-CHEK Aviva® and ACCU-CHEK Nano® created at Roche Diagnostics.

ning from the electrode system in the strip to electrical contacts that insert into the glucose meter (see Figure 2). The reagent, which consists of a glucose-reactive enzyme and a very stable chemical referred to as a proto-mediator, is deposited on these electrodes during manufacturing and then dried. A capillary channel constructed over the electrode system receives a blood sample that rehydrates the reagent, causing it to react with glucose in the blood. “The initial reaction of glucose with the enzyme converts the proto-mediator

to a reactive, low-potential mediator, which carries out the rest of the reaction,” explains Harvey Buck, principal scientist at Roche Diagnostics Operations, Inc.

» SIMULATION UNVEILS CHEMICAL AND ELECTRICAL MYSTERIES

THE CURRENT RESPONSE to a DC voltage applied at the electrodes during the reaction predicts glucose concentration in a blood sample, providing crucial information that tells a patient what action to take to correct their blood sugar levels. But configuration and manufacturing of the test strip affect this response accuracy. Using two COMSOL Multiphysics® software simulations, the Roche team was able to study a new test strip design—one of several they are investigating—and isolate the chemical reactions from the electrical, mechanical, and temperature conditions so that they could analyze the voltage response.

The isolated system contains many parameters and coupled variables, such as concentrations of different chemical species. The reagent system has so many complex interactions between the chemicals and their reactions that it was difficult to predict the response to different measurement methods or interfering substances. So the team made the simplifying assumption that mass transport of chemicals only occurs in a very thin layer above the electrode, thin

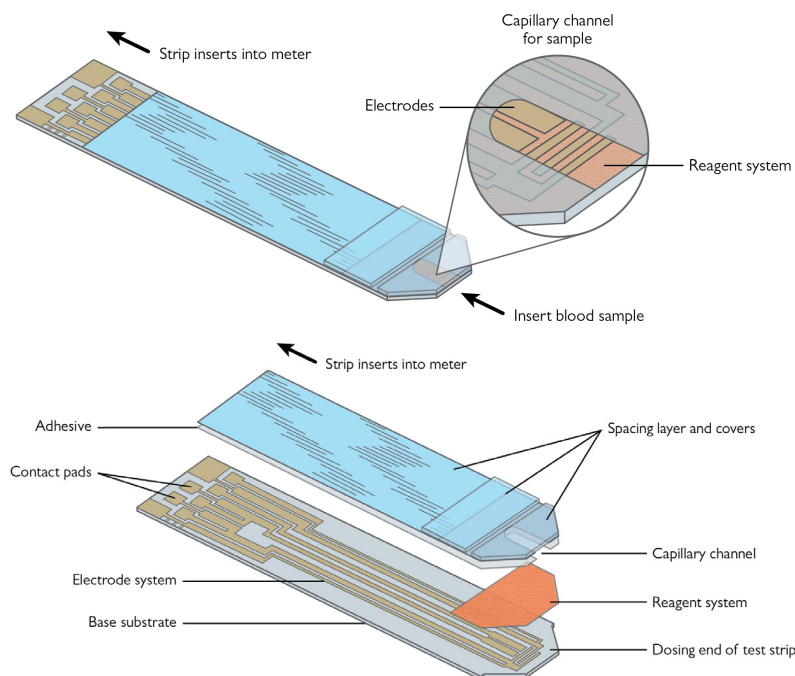

FIGURE 2: Schematic of test strip components. The chemical reaction occurs right on top of the electrodes. Adhesives and spacing layers form the curve of the capillary channel and bind together the electrodes, reagent system, and top and bottom covers.

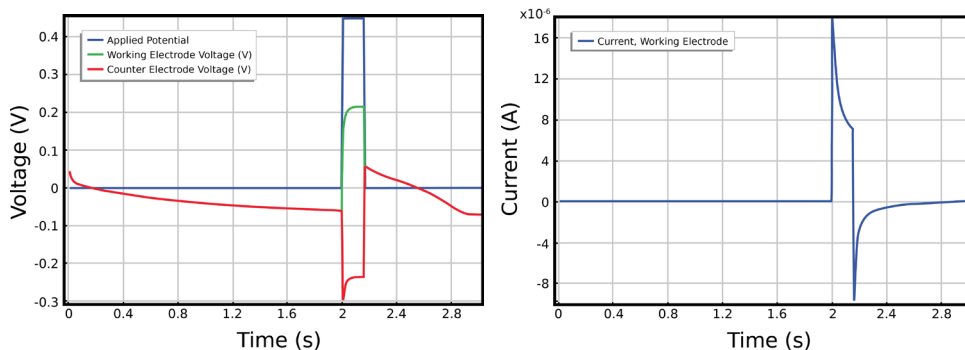

FIGURE 3: Simulation results showing the applied potential difference and the working and counter electrode potentials in the Roche sensor (left), as well as the current response to a potential difference step (right). The current response is proportional to the glucose concentration in the sample. The working and counter electrode potentials (green and red, respectively) are not measurable and are only available through the simulation.

enough for the reactivity to be considered uniform in the direction perpendicular to the surface. “We built a one-dimensional model that lets us understand and predict the responses, which required a combination of Michaelis Menten enzyme kinetics and mixed Butler-Volmer electrode

kinetics,” Buck comments.

Having established rates for the different reactions, the relevant equations were then easy to implement in the software. By restricting the model to one dimension, it was possible to predict the sensor response to different DC potential profiles with reasonable solu-

tion times (see Figure 3).

But the DC current is also affected by temperature and red blood cell fraction in the sample (called hematocrit), so prior to the DC measurement, an AC signal is applied to

obtain impedance information used to compensate for these effects (see Figure 4). These are combined with the DC measurements in a mathematical algorithm, giving the sensor the information needed to make a truly accurate glucose prediction.

The capabilities of COMSOL® software proved particularly valuable for interpreting these complex measurements. “We quickly found during our modeling process that when you try to apply a large potential step to create diffusion-limited flux at an electrode, you risk causing unrealistically high potential calculations,” says Buck. “In COMSOL it’s very easy to use a log transform of the concentration variables, which really simplified the analysis process.”

“The impedance measurements are very sensitive to the sample and not very sensitive to the reagent,” Buck continues. “The electrode arrangement to enable impedance measurement is an integral part of the sensor design, and has a great influence on the measurement sensitivity.” Buck’s team built a second model of the cell to solve the electrical problem, this time in 3D. “The sample conductivity in the cell serves as a proxy for hematocrit variation. We’re able to investigate different electrode configurations and materials, and predict the sensitivity of the

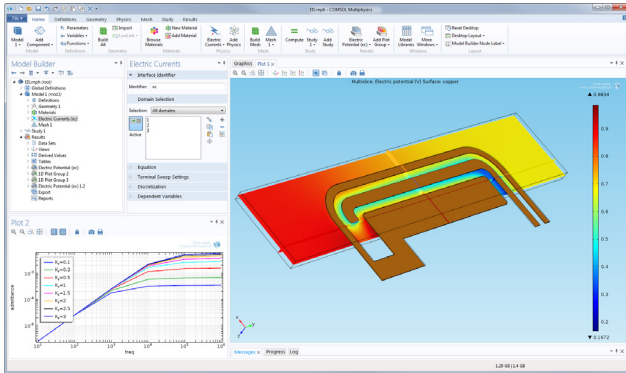

FIGURE 4: Buck's 3D COMSOL simulation showing the admittance response for different conductivities, plotted with a log scale (lower left) and a plot of the electric potential in the sensor measurement zone (right). The gold electrodes contact the electrolyte at a surface impedance interface.

“We’re able to investigate different electrode configurations and materials, and predict the sensitivity of the impedance measurements to hematocrit as well as to other mechanical properties of the sensor, such as capillary height and spacer placement.”

—HARVEY BUCK, PRINCIPAL SCIENTIST, ROCHE DIAGNOSTICS

impedance measurements to hematocrit as well as to other mechanical properties of the sensor, such as capillary height and spacer placement.” (See Figure 5.)

The electrodes are fabricated from sputtered metal films whose resistance significantly affects the impedance measurements and potential distribution. It’s impossible to measure the potential drop across the electrodes or within the electrolyte in the measurement cell without physically disturbing the system, but it is relatively easy to simulate it.

Relying on the COMSOL results for guidance, Buck adjusted the shape, length, and spacing of the working and counter electrodes until he had optimized the electrode design for impedance measurements. Ultimately, he was able to maximize the electrode sensitivity to hematocrit levels while minimizing manufacturing tolerances—thereby

ensuring an accurate impedance measurement for the DC signal compensation. This paved the way for the new configuration to move toward production.

» APPROACHING NEW HORIZONS FOR GLUCOSE MONITORING THROUGH THE CHEMICAL

and electrical response correction modeled in COMSOL, the researchers at Roche have gained greater insight into their new sensor design and are delivering glucose monitors that correct the DC signal for more accurate measurements. Their innovative system, including its built-in sensing capabilities, sets a new standard for biosensing devices. Simulation allowed them to investigate parameters that were impossible to measure experimentally, make informed design decisions, and optimize their electrode configuration. Their continued research and modeling work is leading to the production of these new sensors and, ultimately, better care for persons with diabetes. ©

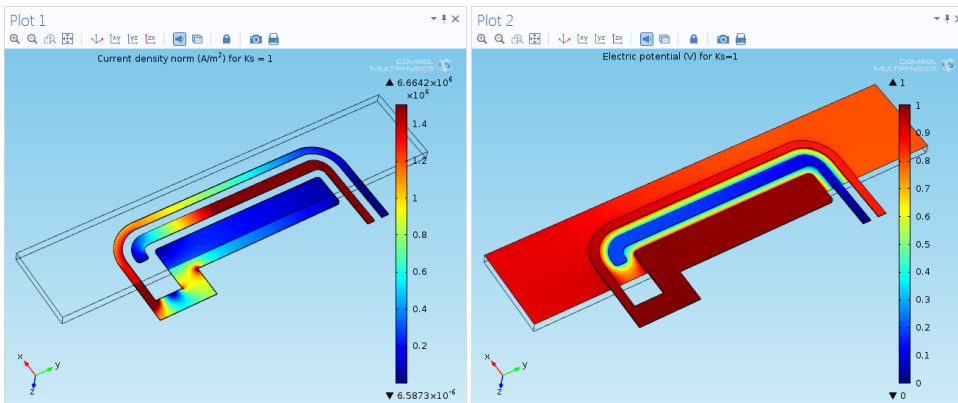
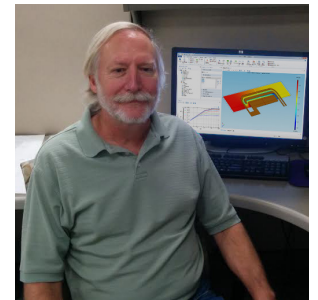

FIGURE 5: COMSOL simulation results showing the current distribution (left) and electric potential (right) in the electrodes and electrolyte.



Harvey Buck, principal scientist, Roche Diagnostics.

SIMULATING PRINTHEAD UNIMORPH ACTUATORS AT FUJIFILM DIMATIX

Engineers at FUJIFILM Dimatix have used multiphysics simulation to gather compliance data for improving industrial printhead actuator performance.

By **LEXI CARVER**

THE REACH OF INDUSTRIAL INKJET PRINTERS is truly incredible—from commercial packaging and wide-format graphics to signage, textiles, and even electronic applications, inkjet printing enables the information sharing and communication that surrounds our everyday activities. FUJIFILM Dimatix, a premier producer of commercial inkjet printheads, is now using multiphysics simulation in the development of the MEMS actuators driving their newest ink deposition products.

» PRINTING WITH MICRON-SCALE PIEZOELECTRIC ACTUATION

A PRINCIPAL SCIENTIST on the research team at FUJIFILM Dimatix, Chris Menzel, is studying printhead actuation in order to design FUJIFILM's newest unimorph diaphragm actuators. These actuators are created in a MEMS fabrication process using a high-performance thin-film piezoelectric layer. This layer is a high-quality proprietary sputtered version of lead zirconium titanate (PZT), an electroceramic that changes shape under an applied electric field and is used in many transducers. The PZT is bonded to a silicon membrane and the actuators are then arrayed across the surface of a wafer, with each one corresponding to a tiny jet consisting of flow channels and a nozzle (see Figures 1 and 2). Thousands of these systems are packed tightly together in the printhead.

The components of each jet (the fluidic channels and the

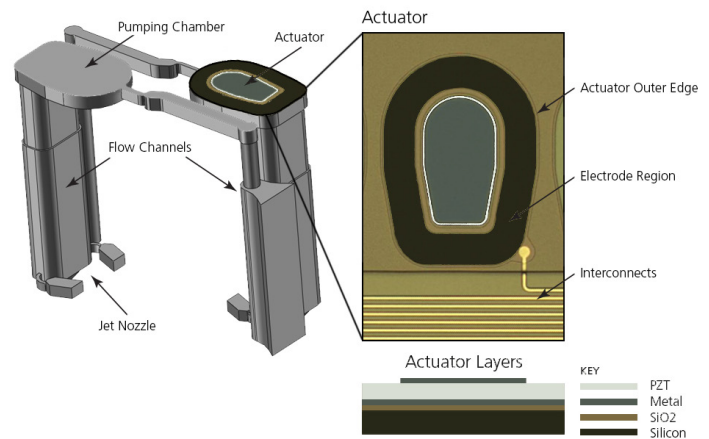

FIGURE 1: The printhead geometry developed by FUJIFILM. Each actuator sits on top of a pumping chamber containing a reservoir full of ink. Below the chamber are flow channels that carry ink to the nozzle.

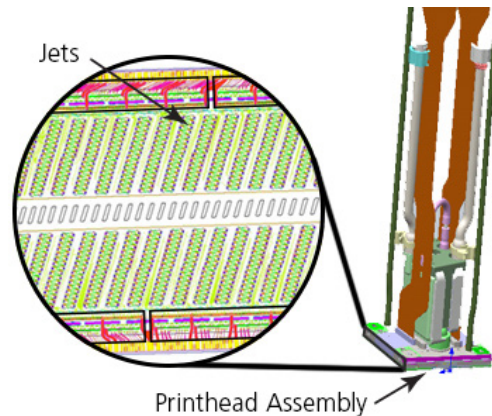

FIGURE 2: Magnification of jets on the wafer and their location in the printhead assembly.

actuator) combine to form a resonant fluidic device. Upon electrical stimulation of the PZT by pulses tuned to stimulate the jet's resonance, the actuator deflects and generates acoustic waves within the closely coupled flow channels. The jet design effectively converts the pressure wave into an oscillating flow, which has to over-

come the surface tension at the nozzle in order to throw an ink drop. When the resulting fluid momentum is large enough, the droplet is propelled outward and onto a substrate.

The goal of Menzel's design work was to define an actuator and jet flow channels that combine to generate a droplet meeting a target mass at a given

velocity, with a target maximum firing frequency for the available voltage. Implicit in this design process is the need for miniaturization and the associated lower cost. With this in mind, the primary concerns in actuator design are maximizing deflection, minimizing size, and matching the actuator's impedance to the flow channels and the nozzle.

» SIMULATION REVEALS ACTUATOR COMPLIANCE AND OUTPUT

A TWO-STAGE MODELING approach was needed because the actuator performs its function within a jet system. In the first stage, Menzel determined functional parameters for various actuator geometries. He then used these parameters in a complete jet model to determine how the whole system would respond.

"We set up a COMSOL Multiphysics® software simulation to determine the actuator functionality," Menzel said. "Simulations offer an understanding of the relationships between functional parameters and the many layer thicknesses, boundary conditions, and sizes our process can generate. The software's ability to efficiently

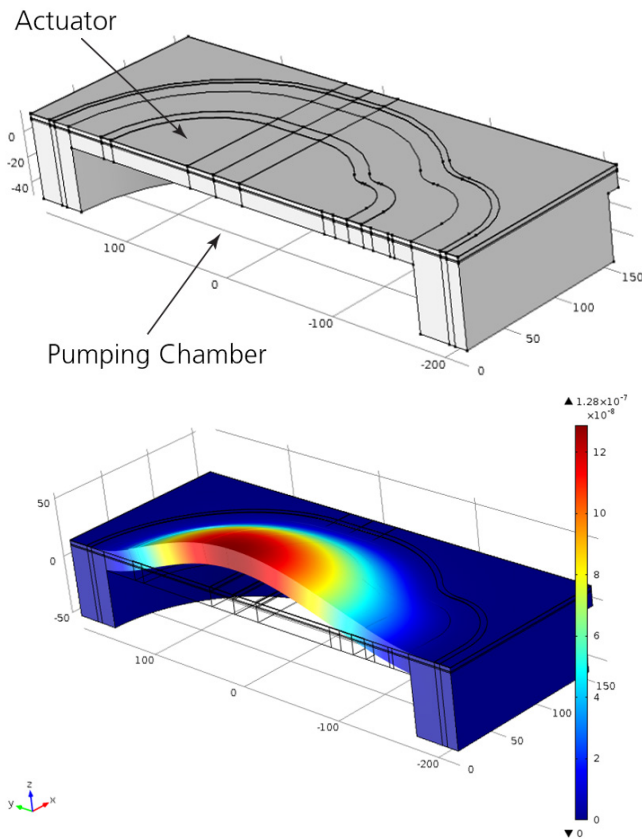

FIGURE 3: Top, Menzel's COMSOL® software model showing half of the actuator geometry with metal, silicon, PZT, electrodes, and pressurized ink chamber. Bottom, simulation results showing the deflection of the actuator.

sweep through a large set of these variables and deliver easy-to-interpret results is of great value. It allows us to easily optimize our total system response, and hence, our product."

He modeled half of the actuator geometry along its central axis and included

different layers for the silicon, metals, insulators, and PZT (see Figure 3, top). He also included a section of the ink-filled pumping chamber below the actuator and a section of a neighboring flow channel, then performed a simulation to extract the

actuator's deflection under a pressure load (known as compliance) and the deflection under a voltage load (known as output) (see Figure 3, bottom). Menzel ran the study over a wide range of actuator geometries. The resulting values were applied to a larger-scale model used for system-level design optimization.

» LOOKING AHEAD TO FASTER, SMALLER PRINTHEADS

THE COMSOL RESULTS led Menzel to an updated design by giving him the information needed to fit a new device to tight specifications and smaller actuator geometries. The multiphysics model revealed valuable information that allowed the engineering team to better understand the ins and outs of their actuator and jet. Modeling remains the starting point for evaluating actuator concepts and product feasibility; the associated reduction in design time is critical to effective and efficient product release. Even higher quality printing will soon be on the market as FUJIFILM Dimatix continues to lead the industry in printhead design, supported by simulation. ©

“ The software's ability to efficiently sweep through a large set of these variables and deliver easy-to-interpret results is of great value. It allows us to easily optimize our total system response, and hence, our product.”

—CHRIS MENZEL, PRINCIPAL SCIENTIST, FUJIFILM DIMATIX

SIMULATING THE PIEZOELECTRIC EFFECT

BY YESWANTH RAO

PIEZOELECTRIC MATERIALS are a family of solids, some natural and some man made, that become electrically polarized as a result of mechanical strain, a phenomenon known as the direct piezoelectric effect. They also exhibit an inverse piezoelectric effect where a mechanical strain results from an applied electric field. Piezoelectric materials are natural transducers that are used in many kinds of sensors and actuators.

The COMSOL Multiphysics® software offers a predefined *Piezoelectric Devices* interface that couples electrostatics and structural mechanics (Figure 1), which are essential for modeling these phenomena.

For accurate modeling, material properties and orientation must be carefully described. The *Piezoelectric Devices* interface allows the user to specify material properties in Stress-Charge or Strain-Charge form (Figure 2), with options for defining material orientation using Euler angles.

Piezoelectric materials are usually one of many components in a device. To capture the true behavior of the device as a whole, it is necessary to model the interactions between the piezoelectric devices and the surrounding materials. The multiphysics modeling capabili-

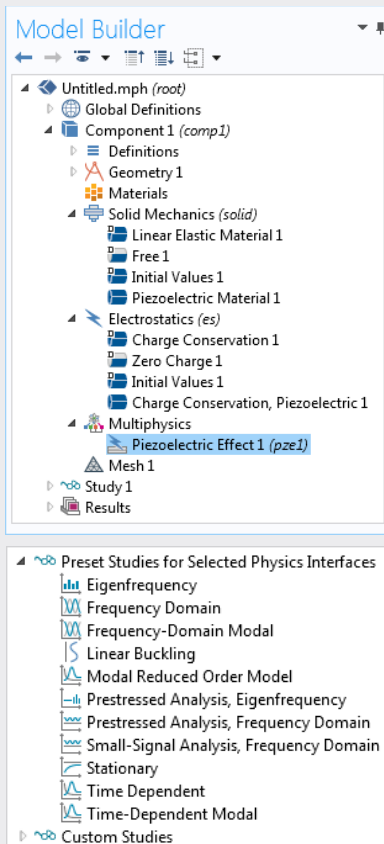

FIGURE 1: COMSOL® software Model Builder showing the setup for simulating the piezoelectric effect (top) and studies available to the user to simulate a piezoelectric application (bottom).

ties in the COMSOL® software allow the *Piezoelectric Devices* interface to be readily coupled with physics such as pressure acoustics, fluid flow, and structural vibrations (Figure 3). It is also important to describe damping

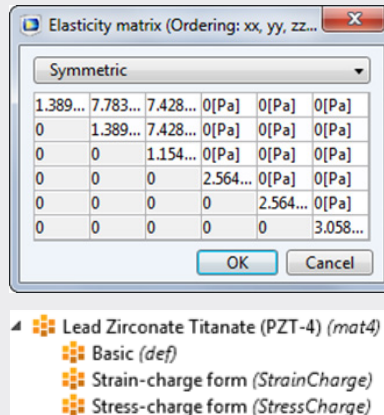

FIGURE 2: Strain-charge form settings showing the elasticity matrix, accessible from the Materials node in the Model Builder.

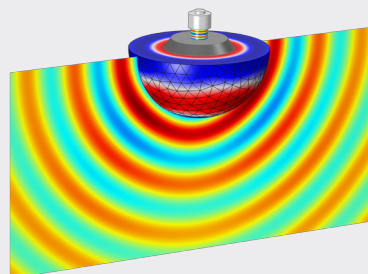

FIGURE 3: Simulation of a piezoelectric tonpilz transducer with results showing the acoustic pressure levels, including the far-field and voltage distribution in the piezoceramic rings. These transducers are used for low-frequency, high-power sound emission.

mechanisms that may affect device performance. COMSOL allows users to include mechanical damping, dielectric losses, conduction losses, and piezoelectric coupling losses.

HPC-ENABLED SIMULATION AIDS IN THE DESIGN OF CUSTOMIZED HIGH-POWER ELECTRICAL DEVICES

COMSOL Multiphysics and its HPC capabilities get the best designs to customers more quickly than ever before.

By **DEXTER JOHNSON**

BLOCK TRANSFORMATOREN-ELEKTRONIK is a leading manufacturer in the field of coiled products that are used in a wide variety of industries, especially for electronics applications.

BLOCK engineers design custom transformers, power supplies, EMC filters, and reactors (see Figure 1), which usually have to meet precise specifications concerning working frequencies, product sizes and weights, electrical power losses, electrical insulation, as well as varying environmental conditions, including dirt, temperature changes, or moisture. Additionally, such equipment must often have product lifetimes of 30 years.

“Depending on the customer’s application, there are restrictions to the materials that may be used,” said Marek Siatkowski, who is responsible for all of BLOCK’s simulation activities. “For example, in railway applications, the materials must meet strict requirements like flammability standards, smoke toxicity in case of fire, etc. We don’t just open our catalog and they pick a device. The customer specifies a size and their requirements and each time we must do a new set of calculations.”

Under all these circumstances, BLOCK found it increasingly more difficult to design inductors and transformers with aging simulation software. To save costs and in order to provide improved services to their customers, the company needed to find a way to reduce the number of prototypes it created before finalizing a design.

With this in mind, the company turned to the COMSOL Multiphysics® software for its ease-of-use, flexibility, and

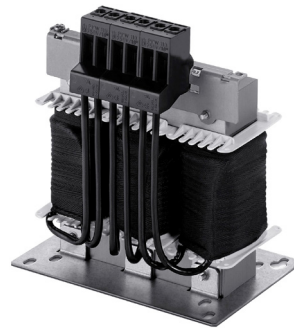

FIGURE 1: Layout of a line reactor used to filter out spikes of current and reduce injection of harmonic currents into the power supply.

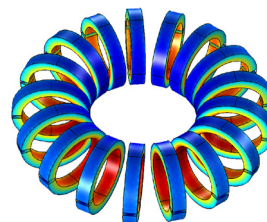
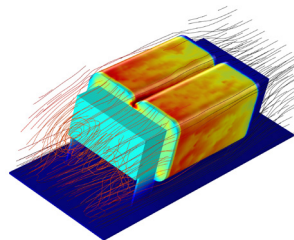

FIGURE 2: Simulation of an air cooled DC choke where temperature distribution and velocity streamlines are shown (top). Magnetic flux density in a toroidal choke (bottom). Its inductance is numerically determined as a function of inner and outer radius and wire thickness.

HPC (high-performance computing) capabilities.

“We can model new devices and find critical areas, where, for example, electromagnetic losses are high or the temperature of the device reaches some threshold,” said Siatkowski. “With COMSOL

Multiphysics, we can identify these areas and simulate the relevant physics effects so that we can quickly and accurately find ways to improve the design.”

The research department is analyzing magnetic characteristics and hysteresis losses in several soft magnetic materials in the BLOCK testing laboratory. One of the main reasons the company uses COMSOL® software is that it allows them to easily insert their own formulas developed over years for all these characteristics and to use them for their simulations.

» HPC LEADS TO GREATER THROUGHPUT

IN ADDITION to using multiphysics simulation, BLOCK is benefiting from the HPC capabilities that COMSOL Multiphysics offers: they can run their simulations on a multicore workstation with no limit to the number of cores and on a cluster with no limit to the number of compute nodes. This offered them improved efficiency regardless of whether a simulation is run on a workstation or a cluster; their R&D team can now quickly deliver the best products to customers.

Siatkowski uses COMSOL to set up models for many of BLOCK’s devices, which are often difficult to calculate analytically, but have a geometry that can be based on a few parameters and specific customer’s needs. One example of a model that

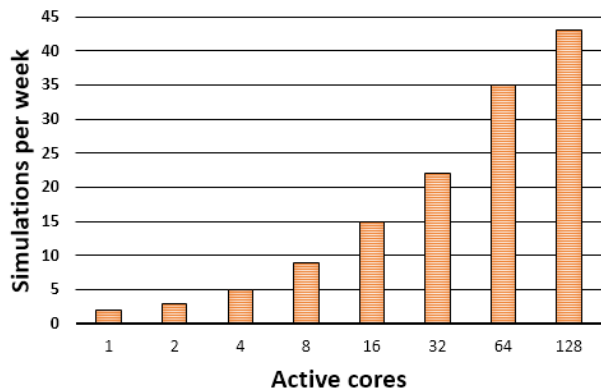

FIGURE 3: Moving from a single workstation with eight cores to a modestly sized cluster can lead to a significant performance increase.

Siatkowski built was for a DC choke (see Figure 2).
 “With COMSOL Multiphysics, I can run a simulation that has parameters like width, height, thickness of the wires, etc. and explore the entire design space defined by our teams and customers. Our product developers and sales teams can now work more efficiently and easily find the best solution,” explained Siatkowski.

» **IT’S ALL IN THE ARCHITECTURE**

“FOR SMALLER MODELS, I can build a model on my workstation and run the computation there,” explained Siatkowski. “But for the larger models, my workstation is not fast enough and does not have enough memory.”

This is when the flexible nature of COMSOL came into play and BLOCK fully benefited from the available HPC capabilities supported by the software

architecture and generous licensing. Siatkowski instead runs his models on several computers with multiple cores.
 “I’m currently using a cluster with 22 cores and 272 GB of RAM and I can easily run my simulations remotely on it,” said Siatkowski. “COMSOL supports distributed memory computing where each node of a cluster can also benefit from local shared memory parallelism; this means that I’m getting the most out of the hardware available.” The speedup obtained in terms of simulations per week for a large electrical study is shown in Figure 3.

After executing the simulation on the high-performance computer, Siatkowski reviews the result on his workstation, where he can then also perform postprocessing. “The benefit of this is that during the simulation itself, my workstation is free and

I can continue with other work and even do pre- or postprocessing on other models. The architecture

that the COMSOL software has allows us to be more productive and service our customers better.” ©



From left to right: C. Kliesch (Bachelor Student), Dr. M. Siatkowski (Advanced R&D), M. Owzareck (Advanced R&D), A. Bimidi (Student Apprentice), Y. Kumar (Master Student), Dr. D. Kampen (Head of Advanced R&D)

CONTINUED FROM PAGE 32

These tools allow our engineers to tailor our designs to meet customers’ needs with minimal time and input. In the past, these recurring analyses took hours and required an employee specializing in simulation; with a COMSOL application, employees at all levels of our organization can run simulations nearly effortlessly.

All told, multiphysics simulation and application design through COMSOL allows our designers to make better, more competitive products. Efficiency is core to our company philosophy—doing more, using less. This is not limited to the efficiency of our products, but also in the way we conduct business, generate ideas, and create new designs. The Application Builder is now a vital element in helping APEI build the best wide band gap solutions possible. ©



BRICE MCPHERSON is a senior engineer at APEI, with 11 years of experience in high performance, extreme environment wide band gap power semiconductor packages. He specializes in the parametric CAD design and analysis of APEI’s power modules and conversion systems.

SIMULATION APPS STREAMLINE THE DESIGN OF POWER ELECTRONICS

By **BRICE MCPHERSON**

POWER ELECTRONICS ARE ESSENTIAL in nearly every application that uses electricity, from cell phone chargers to industrial scale power distribution. Different applications require converting power from one form to another. For example, driving the motor on an electric vehicle requires power switches, drivers, filters, sensors, and control circuitry. These conversion systems need to process power as efficiently, safely, and cost-effectively as possible.

At APEI we are pushing the limits of power electronic systems, developing advanced solutions utilizing wide band gap semiconductors that can block higher voltages, carry larger amounts of current, switch on and off more quickly, and more effectively dissipate waste heat than traditional semiconductors. These benefits are key to processing large amounts of power in increasingly smaller volumes and at higher efficiencies.

The COMSOL Multiphysics® software and the Application Builder are fundamentally changing the way that we design, support, and market our products. In the real world, most problems are not constrained to singular, isolated physical phenomena. For electronic systems, thermal, electrical, and mechanical behavior are closely intertwined; their effects and

interactions must be studied simultaneously in order to see the full picture of factors driving performance. COMSOL Multiphysics simulations have been essential tools for our engineers to extract a more detailed understanding of our products, virtually assess real-world performance, and reduce the amount of prototyping needed.

When the Application Builder was released, we were eager to try it out. It was surprising to see how easy it was to build our first application—a tool to analyze the fusing current and impedance of the tiny bond wires used to interconnect semiconductor devices. It took little time to transition an existing COMSOL® software simulation to an application designed for ease of use, while still based on a powerful multiphysics model. A drag-and-drop graphical interface, straightforward controls and entry fields, and full integration within the COMSOL environment narrowed the learning curve considerably. In short, if you can build a model, you can easily build an app from it.

We now have multiple apps ranging from simple design tools to comprehensive analyzers that extract all relevant performance and design metrics for custom configurations of our power modules.

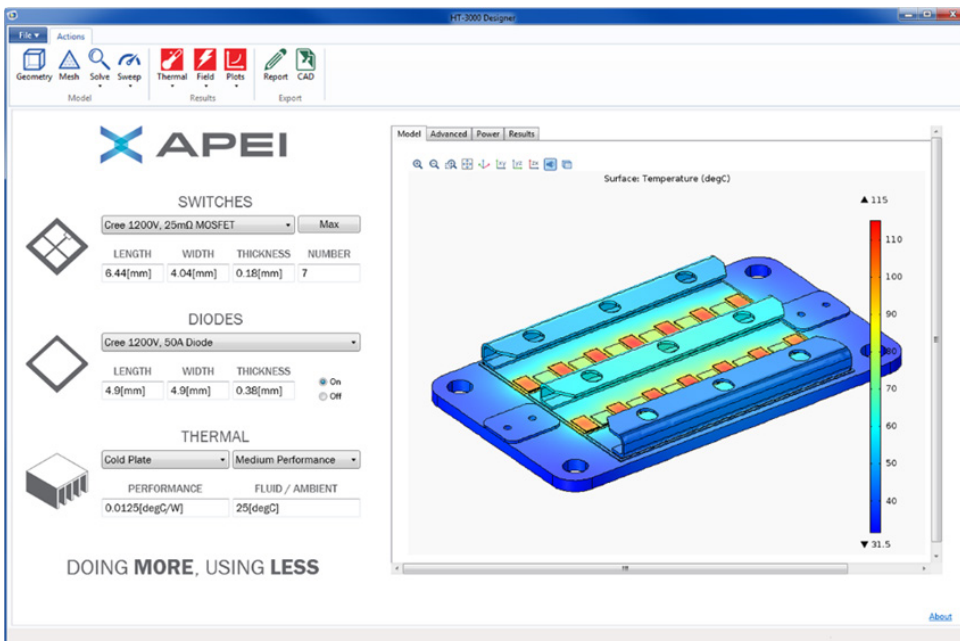

A COMSOL® software simulation application created at APEI for predicting the performance of different power module designs.

CONTINUED ON PAGE 31